

Improving Power and Energy Efficiency of Linearly Equalized Baseband Cable Transmission Links

Christoph Lange¹ and Andreas Ahrens²

¹*Hochschule für Technik und Wirtschaft Berlin, University of Applied Sciences, 10313 Berlin, Germany*

²*Hochschule Wismar, University of Applied Sciences: Technology, Business and Design, 23966 Wismar, Germany*

Keywords: Transmission System, Telecommunication Network, Power, Energy, Baseband, Cable, Equalization.

Abstract: Telecommunication networks have been identified to exhibit a substantial electrical power and energy demand. Therefore it is important to utilize power and energy efficient systems as building blocks for such networks. In wired access networks copper cables are used for highspeed data transmission. Important technical indicators for power and energy efficiency of transmission systems are transmit power and energy per bit. In this work it is investigated how transmit power and energy per bit in linearly equalized multilevel baseband cable transmission systems can be minimized by exploiting degrees of freedom in the transmission link design for given throughput and transmission quality. First, the constellation size is a degree of freedom: Its optimization leads to minimum values of transmit power and energy per bit depending on the interplay between throughput and band limitation of the cable. Second, the partitioning of the equalization to transmitter and receiver is a degree of freedom: Here, a uniform distribution of the linear equalizing function is found to be optimum in terms of minimum transmit power or energy per bit at a given transmission performance and quality. The results show that the optimization of constellation size and equalization partitioning leads to significant transmit power and energy-per-bit savings compared to conventional baseband cable transmission systems.

1 INTRODUCTION

Telecommunication networks exhibit a significant electrical power and energy demand (Lambert et al., 2012). Since communication services are indispensable and the intensity of their usage is rising, existing telecommunication networks are continuously extended in terms of coverage and performance capability and network sections or even whole new networks have to be installed. Hence it is important to employ power and energy efficient transmission and networking systems to limit the networks' overall power and energy demand. Because of the importance of the sustainability of telecommunication networks a vast number of research and development activities has been initiated and conducted in the past few decades to understand and to limit – or even to reduce – the power and energy demand of communication networks and transmission systems, e. g. (Pickavet et al., 2008; Agrell and Karlsson, 2009; Kilper et al., 2011; Bolla et al., 2011; Tsiropoulou et al., 2012; Kilper et al., 2012) – and many more.

In fixed access networks still twisted-pair copper cables dating back to the analogue telephone network era are widely utilized for broadband data transmis-

sion to apartment buildings and individual homes – at least as long as optical fiber access is not available extensively and at a reasonable retail price. Wired access networks typically consist of a large multitude of access lines and therefore the transmission over those copper cables has a significant share in the overall telecommunication networks' power and energy consumption (Lange et al., 2011).

For that reason insights are of interest on how to design copper cable transmission systems power and energy efficiently. It is important to identify degrees of freedom that are accessible for optimization in the design or adaptation process of the transmission system in a way that the power and energy demand becomes a minimum for given boundary conditions concerning, e. g., bit rate and bit error probability. Transmit power and energy per transmitted bit are important technical indicators for the energy of transmission systems: Therefore they are used as measures for the power and energy efficiency throughout this paper. When considering whole telecommunication networks, this transmission energy usage represents a lower bound to the overall energy or energy per bit—as at least the traffic has to be transferred between network nodes, but other network

functions such as switching, buffering, network control and routing have to be performed, too, and exhibit additional energy demand (per transferred bit) (Kilper et al., 2010). The analysis in this paper focusses on the transmission problem, the impact of the mentioned other network functions and their computational complexity on the energy efficiency is left for future work.

In order to obtain general insights on the transmission problem stated above primarily by means of clear and concise analytical calculations throughout this work baseband transmission systems operating over copper cable channels are investigated. Furthermore, baseband transmission may regain practical interest for application in copper-based access networks as there are hints that the prevalently utilized multi-carrier systems could be not as cost-efficient as other modulation formats when it comes to hardware implementation (McCune, 2013). Here, the simpler implementations of baseband transmission systems could facilitate an improved cost efficiency.

Often, sensor data are backhauled via existing communication networks and thus copper cables of the telecommunication access networks are parts of overall sensor networks. Therefore the power and energy efficiency of those copper transmission links is important for the overall energy efficiency and sustainability of sensor networks. Furthermore, the energy-optimized baseband systems can be used also directly for linking wired sensors—as particularly the energy efficiency in distributed sensor networks with lots of remote sensors is of overwhelming importance for their energy efficient and sustainable operation.

Usually, the desired throughput – the bit rate – of a link is given as a performance requirement. Furthermore, a certain transmission quality is required for the link to operate reliably – translating into a fixed bit error probability. Beyond that, the channel and disturbance characteristics are typically given.

In transmission systems the number of transmission levels – the constellation size – is a first degree of freedom subject to optimization: In (Lange and Ahrens, 2021) the behaviour of an AWGN (additive white Gaussian noise) baseband transmission system in terms of transmit power and energy per transmitted bit has been studied with respect to the constellation size of a multilevel transmission together with a baseband cable transmission system with linear equalization in the receiver.

Therefore, as a starting point, in this paper the transmit power and the energy per transmitted bit will be calculated for linearly equalized baseband cable transmission systems as functions of the constellation size: An optimization of the constellation size is pos-

sible and necessary with respect to minimum transmit power or energy per bit, respectively. A second degree of freedom in linearly equalized transmission systems is related to the part of the equalization that is performed at the transmitter side and the part that is implemented at the receiver side. This partitioning leads to an optimum segmentation of the equalization to transmitter and receiver – and hence to a minimum transmit power or energy per transmitted bit, respectively: The transmit power or energy per bit can be further reduced.

The novelty of the paper is based on the identification of degrees of freedom when designing or adapting a baseband transmission scheme operating via a linearly equalized copper cable transmission channel with regard to minimum power and energy demand. Both, the constellation size and the partitioning of the linear equalization to transmitter and receiver are identified as such degrees of freedom. They are optimized with respect to minimum transmit power or energy per bit, respectively. The results show that by optimal choice of those two parameters significant improvements in power and energy efficiency can be achieved.

The remaining part of this paper is organized as follows: In section 2 the transmit power and the energy per bit for a conventional multilevel baseband cable transmission with complete receiver-side linear equalization are calculated for given bit rate and bit error probability. Results are presented as functions of the constellation size. In section 3 the transmission model for the cable transmission is generalized by partitioning the linear equalization to transmitter and receiver: Transmit power and energy per bit are derived for this modified setup and results are presented – also including achievable savings when using the degrees of freedom for optimization. Section 4 summarizes major findings, provides concluding remarks and gives an outlook on potential future work.

2 ENERGY EFFICIENCY OF CABLE TRANSMISSION WITH LINEAR EQUALIZATION IN THE RECEIVER

2.1 Cable Transmission Model

The binary digital data source emits a sequence of bits for transmission over the copper cable channel. According to the transmission model shown in Figure 2 binary data with a bit rate f_B are converted by a multilevel coder in the transmitter to symbols

with s amplitude levels—and hence a symbol rate of $f_T = f_B/\text{ld}(s)$.¹ After filtering with the transmit filter transfer function $G_s(f)$ an s -ary pulse amplitude modulated signal is transmitted over the copper cable channel.

The copper cable channel is modelled by the transfer function

$$G_k(f) = e^{-\ell\sqrt{j\frac{f}{f_0}}}, \quad (1)$$

where ℓ denotes the cable length (in km) and f_0 represents the characteristic cable frequency (in $\text{MHz} \cdot \text{km}^2$). The characteristic cable frequency f_0 is a cable-specific constant that depends, e. g., on the wire diameter and on the insulation material. The transfer function (1) can be derived via transmission line theory for the RC range – leading to a strong low-pass behaviour of the channel. Inevitable noise disturbances are modelled by additive white Gaussian noise (AWGN) of power spectral density Ψ_0 .

Figure 1 shows the amplitude frequency response of an exemplary twisted-pair copper cable with a wire diameter of 0,6mm for two cable lengths: The low-pass characteristic of the cable transmission channel is clearly recognizable. Furthermore it becomes obvious, that a longer cable ($\ell = 2\text{km}$) shows a stronger low-pass band limitation than a shorter cable ($\ell = 0,5\text{km}$).

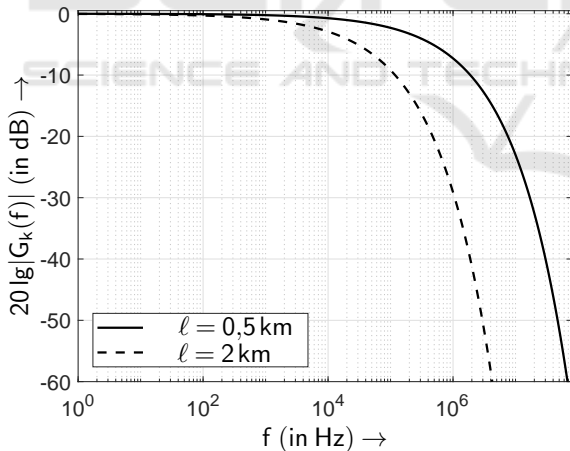

Figure 1: Cable transfer function of a twisted-pair copper cable with a wire diameter of 0,6mm ($f_0 = 0,178\text{MHz} \cdot \text{km}^2$) for two cable lengths.

The transmission channel in causes signal distortion leading to intersymbol interference (ISI) which may lead to bit errors. Therefore equalizers are utilized: The equalizer's main task is to eliminate – or at least to minimize – the distorting impact of the

¹The notation $\text{ld}(x)$ describes the *dyadic logarithm*: $\text{ld}(x) = \log_2(x)$.

channel on the wanted signal. In one way or another for this purpose the equalizer has to establish a form of the inverse of the channel's transfer function in the signal path. The transmission model depicted in Figure 2 contains a conventional baseband cable transmission link where the cable's impact is completely linearly equalized by the inverse of the cable transfer function ($1/G_k(f)$) at the receiver side. Although there are a lot of equalization techniques established using digital signal processing methods – e. g. (Proakis and Salehi, 2008; Anderson, 2005) – an equalizer like described above is presumed in order to obtain analytical results and insights – which is a main aim of this contribution.

After filtering with the receive filter transfer function $G_e(f)$ in the receiver and subsequent symbol rate sampling the detector decides on the received signal amplitude. The multilevel decoder maps the detected symbols to the received bits and the sink is provided with a binary data sequence.

The transmit and receive filters $G_s(f)$ and $G_e(f)$ are square-root raised cosine filters (Proakis and Salehi, 2008) with roll-off factor r , respectively: Then the receive signal at the detector input is ISI-free as over the cascade of transmit and receive filter the first Nyquist criterion is met (Proakis and Salehi, 2008) and the cable transfer function is completely equalized.

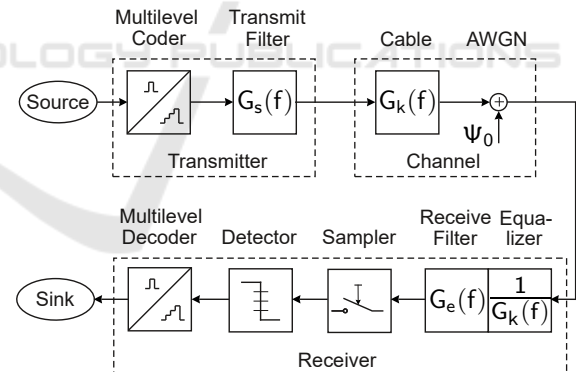

Figure 2: Model of the conventional cable transmission system.

For assessing the transmission quality, the signal-to-noise ratio

$$\rho = \frac{(\text{Half Vertical Eye Opening})^2}{\text{Noise Power}} = \frac{U_A^2}{U_R^2} \quad (2)$$

at the detector input is used. The half-level transmit amplitude is denoted as U_s , i. e. the distance between neighbouring signal amplitude levels is $2U_s$. As the first Nyquist criterion is met, from transmit filter input to receive filter output the half vertical eye opening

equals the half-level transmit signal amplitude: $U_A = U_s$.

With square-root raised cosine receive filter and linear equalization of the channel transfer function by its inverse in the receiver the noise power at the detector input results in

$$U_R^2 = \Psi_0 \int_{-\infty}^{\infty} \left| \frac{G_e(f)}{G_k(f)} \right|^2 df . \quad (3)$$

Assuming Gray coding (Proakis and Salehi, 2008) the bit error probability of the s -ary baseband transmission with (2) finally yields²

$$P_b = \frac{s-1}{s \text{ld}(s)} \left[1 - \text{erf} \left(\sqrt{\frac{\rho}{2}} \right) \right] . \quad (4)$$

2.2 Transmit Power and Energy per Bit Calculation

In order to assess the power and energy efficiency of the cable baseband transmission system the transmit power P_s and the energy E_b per bit are calculated considering the boundary conditions bit rate f_B and bit error probability P_b .

The average transmit power for an equally distributed s -ary random baseband signal, a redundancy-free source and a square-root raised cosine transmit filter is given as³

$$P_s = \frac{U_s^2}{3} (s^2 - 1) . \quad (5)$$

Since the half vertical eye opening in the ISI-free overall channel yields $U_A = U_s$ the signal-to-noise ratio becomes

$$\rho = \frac{U_s^2}{U_R^2} . \quad (6)$$

Solving (6) for U_s^2 and inserting the result in (5) leads to the transmit power

$$P_s = \frac{U_R^2 \cdot \rho}{3} (s^2 - 1) . \quad (7)$$

In order to obtain a relationship of the transmit power P_s on the bit rate f_B and the bit error probability P_b equation (4) is solved for the signal-to-noise ratio ρ :

$$\rho = 2 \left[\text{erf}^{-1} \left(1 - \frac{s \text{ld}(s)}{s-1} P_b \right) \right]^2 . \quad (8)$$

²The function $\text{erf}(x)$ denotes the Gaussian error function (Proakis and Salehi, 2008).

³In this paper a system-theoretic power with the dimension of (voltage)² (with the unit V²) is used. At a real, constant resistance R this is translated into a power in unit W by dividing the system-theoretic power by R .

Finally, by combining (7) and (8) the transmit power P_s for given bit rate f_B and fixed bit error probability P_b results in:

$$P_s = \frac{(s^2 - 1)}{3} \cdot U_R^2 \cdot 2 \left[\text{erf}^{-1} \left(1 - \frac{s \text{ld}(s)}{s-1} P_b \right) \right]^2 . \quad (9)$$

The transmit power (9) depends on the given bit error probability P_b and the constellation size s – which is a degree of freedom and thus subject to optimization targeting minimum transmit power P_s . The noise power U_R^2 is calculated by numerically solving (3): It depends via the symbol rate f_T on the given bit rate f_B and furthermore on the cable parameters (f_0 and ℓ) and the noise disturbance (Ψ_0).

The energy per transmitted bit

$$E_b = \frac{P_s}{f_B} \quad (10)$$

is an important energy efficiency indicator in digital information transmission (Tucker, 2011a; Tucker, 2011b) and with (9) it results in

$$E_b = \frac{(s^2 - 1)}{3} \cdot \frac{U_R^2}{f_B} \cdot 2 \left[\text{erf}^{-1} \left(1 - \frac{s \text{ld}(s)}{s-1} P_b \right) \right]^2 . \quad (11)$$

Furthermore, the energy per bit E_b exhibits not only an important energy efficiency indicator for transmission systems and communication networks, but it constitutes also – together with the noise power spectral density Ψ_0 – an important figure of merit as ratio E_b/Ψ_0 when assessing digital communication systems (Sklar, 2001).

2.3 Transmit Power and Energy per Bit Results

Numerical transmit power and energy-per-bit results are presented using a twisted-pair copper cable with a wire diameter of 0,6mm (characteristic cable frequency $f_0 = 0,178 \text{MHz} \cdot \text{km}^2$) as an exemplary but typical representative of a transmission line in copper-based access networks. The numerical assumptions for the bit error probability P_b and the noise power spectral density Ψ_0 are based on relevant values for baseband transmission systems. The roll-off factors of the square-root raised cosine transmit and receive filters are chosen to be $r = 0,5$. As the constellation size s is a degree of freedom the results are depicted as a function of s or, more precisely, of the number of bits per symbol $\text{ld}(s)$ —to obtain a logarithmically scaled horizontal axis.

First, in Figure 3 the transmit power P_s is depicted as a function of the constellation size s for different bit rates f_B for a copper cable of length $\ell = 2 \text{km}$. This

length is on average representative for a cable that runs from a traditional telephone network exchange as access node to an individual home or multi-dwelling building in a fiber to the exchange (FTTEx) access network architecture (Lange et al., 2008).

The transmit power P_s shows a minimum at an optimum constellation size s_{opt} that depends on the bit rate f_B . When starting from s_{opt} , with rising constellation size s the impact of higher-order constellation sizes known from the AWGN transmission (Lange and Ahrens, 2021) is effective: The higher number of transmission levels and their greater density require higher transmit power for fixed transmission quality. Towards smaller constellation sizes s another mechanism takes effect: The noise power is enhanced since the signal bandwidth – and hence the receive filter bandwidth – is increased requiring a higher transmit power when targeting a constant transmission quality, i. e., a fixed bit error probability.

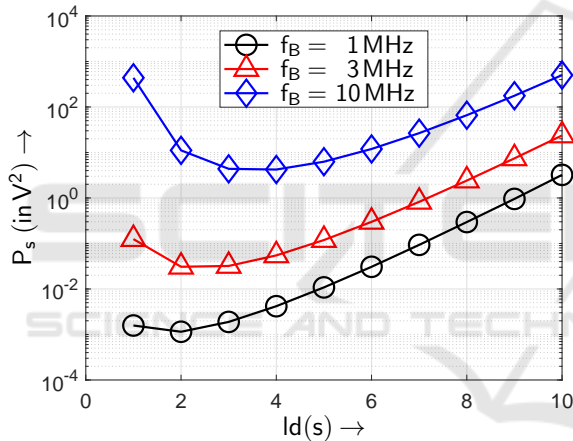

Figure 3: Transmit power P_s as a function of the constellation size s for several fixed bit rates f_B (parameters: $\ell = 2\text{ km}$, $P_b = 1,5 \cdot 10^{-9}$ and $\Psi_0 = 10^{-12} \text{ V}^2/\text{Hz}$).

In Figure 4 the energy per transmitted bit E_b is shown as a function of the constellation size s assuming the same preconditions as in Figure 3. The curves of the energies per bit E_b show a very similar behaviour with respect to the constellation size s as the transmit power P_s . This is because of the fact that each of the transmit power curves is divided (i. e., scaled) by a constant – but for each curve different – bit rate f_B . Therefore, for the optimization of the constellation size s it makes no differences whether it is optimized with regard to minimum transmit power or energy per bit.

Second, in Figure 5 the transmit power P_s is displayed as a function of the constellation size s for different bit rates f_B for a copper cable length $\ell = 0,5\text{ km}$ – which is exemplarily representative for a copper cable that connects an access multiplexer residing in

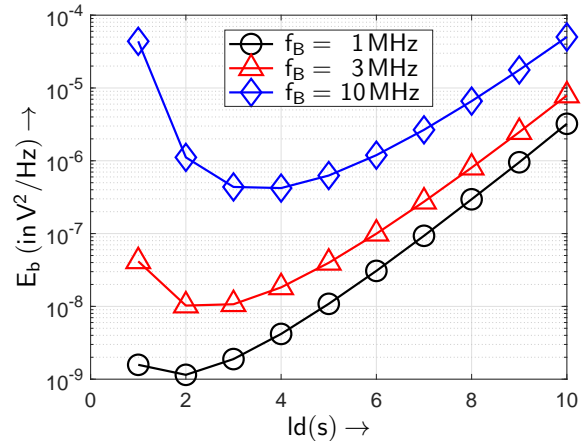

Figure 4: Energy per transmitted bit E_b as a function of the constellation size s for several fixed bit rates f_B (parameters: $\ell = 2\text{ km}$, $P_b = 1,5 \cdot 10^{-9}$ and $\Psi_0 = 10^{-12} \text{ V}^2/\text{Hz}$).

a street cabinet to an individual home or apartment building in a fiber to the curb (FTTC) (Shumate, 2008) access network architecture (also denoted as fiber to the cabinet (FTTCab) (Lange et al., 2008)). In such an access network architecture the access multiplexers are connected backwards to further stages of the telecommunication network by optical fibers. Figure 6 shows the corresponding energy per bit E_b as a function of the constellation size s . Again, the curves of the energies per bit E_b exhibit a very similar behaviour with respect to the constellation size s as the transmit power P_s curves – since both are connected by the scaling factor bit rate f_B , which is fixed for each individual curve.

The principle behaviour of the transmit power and energy-per-bit trajectories is very similar to those in the case with the longer cable ($\ell = 2\text{ km}$). The main difference are the higher bit rates that are possible at comparable transmission performance and quality on shorter cables – since the lowpass effect of the cable is by far weaker as with longer cables.

3 ENERGY EFFICIENCY OF CABLE TRANSMISSION WITH DISTRIBUTED LINEAR EQUALIZATION

3.1 Generalized Cable Transmission Model

The linear equalization frees the wanted signal completely from distortions induced by the cable transfer function. In linear systems the sequence of the signal processing is not relevant to the overall equalization

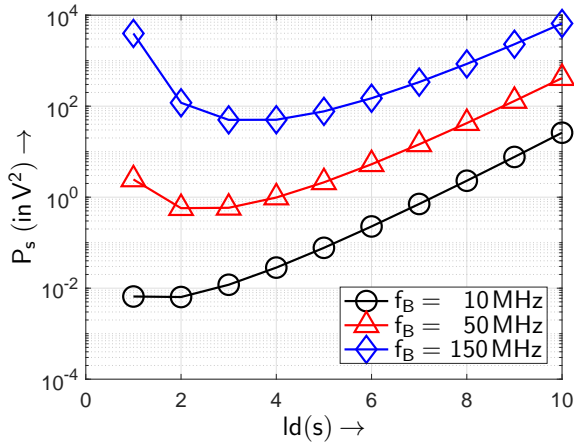

Figure 5: Transmit power P_s as a function of the constellation size s for several fixed bit rates f_B (parameters: $\ell = 0,5 \text{ km}$, $P_b = 1,5 \cdot 10^{-9}$ and $\Psi_0 = 10^{-12} \text{ V}^2/\text{Hz}$).

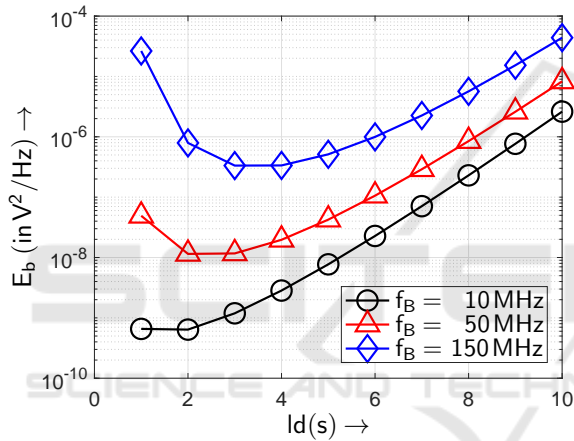

Figure 6: Energy per transmitted bit E_b as a function of the constellation size s for several fixed bit rates f_B (parameters: $\ell = 0,5 \text{ km}$, $P_b = 1,5 \cdot 10^{-9}$ and $\Psi_0 = 10^{-12} \text{ V}^2/\text{Hz}$).

result. Therefore it is possible to shift the equalization or parts of it in the transmission system's block diagram. Thus, the equalizer transfer function $1/G_k(f)$ is divided into two components: A part of the equalization is performed in the transmitter and the remaining part in the receiver. Thence, the partitioning of the equalizer transfer function to transmitter and receiver is another degree of freedom – which is subject to optimization, too.

In Figure 7 the generalized transmission model is shown. All components for multilevel coding and decoding, transmit and receive filtering (in the narrower sense, i. e., concerning $G_e(f)$) as well as for sampling and detection remain as depicted in Figure 7. The only change concerns the generalized transmit and receive filters that now exhibit the transfer functions

$$H_s(f) = \frac{G_s(f)}{G_k(f)^{\frac{m}{m+1}}} \quad (12)$$

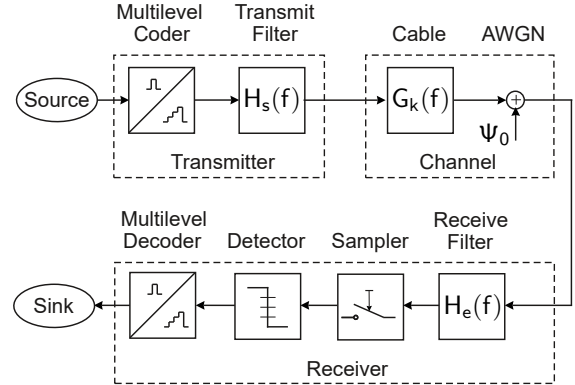

Figure 7: Model of the cable transmission system with equalization partitioned to transmitter and receiver.

and

$$H_e(f) = \frac{G_e(f)}{G_k(f)^{\frac{1}{m+1}}}, \quad (13)$$

respectively. The cable transfer functions' ($G_k(f)$) impact on the transmit signal is – now as before in section 2 – completely and linearly equalized by its inverse $1/G_k(f)$ – but segmented to transmitter and receiver. Transmit filter $G_s(f)$ and receive filter $G_e(f)$ are complemented by equalization components. The parameter m describes the degree of partitioning of the equalization to transmitter and receiver. The overall system from transmit filter input to receive filter output stays ISI-free for arbitrary m as the first Nyquist criterion is met independently of m . The model contains the special cases:

- $m = 0$: Complete equalization in the receiver.
- $m \rightarrow \infty$: Complete equalization in the transmitter.
- $m = 1$: Uniform distribution of the equalization to transmitter and receiver.

Therewith, this transmission model represents a generalization of the conventional transmission model discussed and investigated in section 2.

3.2 Transmit Power and Energy per Bit Calculation

With the power spectral density of the transmit signal

$$\Psi_s(f) = \frac{U_s^2}{3f_T} (s^2 - 1) |H_s(f)|^2 \quad (14)$$

the transmit power in this generalized case can be calculated as

$$P_s = \int_{-\infty}^{\infty} \Psi_s(f) df = \frac{2U_s^2}{3f_T} (s^2 - 1) \int_0^{\infty} |H_s(f)|^2 df. \quad (15)$$

The noise power at the detector input is obtained as

$$U_R^2 = \Psi_0 \int_{-\infty}^{\infty} |H_e(f)|^2 df = 2\Psi_0 \int_0^{\infty} |H_e(f)|^2 df . \quad (16)$$

With (2) for Nyquist-1 transmission ($U_s = U_A$) the relationship $U_s^2 = \rho \cdot U_R^2$ holds and the result for the transmit power with (15), (16) and (8) finally yields

$$P_s = \frac{8}{3} \frac{(s^2 - 1) \Psi_0 \cdot \text{ld}(s)}{f_B} \left[\text{erf}^{-1} \left(1 - \frac{s \text{ld}(s)}{s-1} P_b \right) \right]^2 \cdot \dots \int_0^{\infty} |H_s(f)|^2 df \cdot \int_0^{\infty} |H_e(f)|^2 df . \quad (17)$$

With (17) the energy per bit $E_b = P_s / f_B$ results in

$$E_b = \frac{8}{3} \frac{(s^2 - 1) \Psi_0 \cdot \text{ld}(s)}{f_B^2} \left[\text{erf}^{-1} \left(1 - \frac{s \text{ld}(s)}{s-1} P_b \right) \right]^2 \cdot \dots \int_0^{\infty} |H_s(f)|^2 df \cdot \int_0^{\infty} |H_e(f)|^2 df . \quad (18)$$

The bit rate f_B is directly contained in (17) and (18) and furthermore also – via the symbol rate f_T that determines the bandwidths of the filters $H_s(f)$ and $H_e(f)$ (Lange and Ahrens, 2021) – in both of the integrals. Moreover, the transmission quality (P_b), the disturbance (Ψ_0) and the cable characteristics (f_0 , ℓ) determine the required transmit power or energy per bit, respectively.

Since a part of the equalization is performed in the transmitter (pre-equalization) a frequency-dependent amplification of the signal at the transmitter occurs. In some circumstances a high transmit signal amplitude can arise. In such cases transmit components (e. g. amplifiers) with higher dynamic range are required than in case of complete linear equalization in the receiver. This prerequisite is assumed to be fulfilled for the investigations in this paper.

3.3 Transmit Power and Energy per Bit Results

In this section, firstly the parameter m is optimized numerically with respect to minimum transmit power and energy per bit, respectively. Second, results with optimum equalization partitioning between transmitter and receiver, i. e. optimized m , are compared to the transmit power and energy-per-bit results obtained in the first part of the paper for complete linear equalization in the receiver. The numerical evaluations rely on the exemplary values for signal, disturbance and cable parameters utilized above – unless otherwise stated.

3.3.1 Equalization Distribution Optimization

In Figure 8 the transmit power (17) is shown as a function of the equalization parameter m that describes the degree of distribution of the linear equation to transmitter and receiver according to (12) and (13) for a fixed constellation size s . For $m = 0$ the equalization is completely performed in the receiver (like described in section 2) and for $m \rightarrow \infty$ it resides entirely in the transmitter. Both extreme cases result in the same transmit power from a transmission engineering point of view – neglecting potential practical realization issues (e. g. concerning the linear dynamic range in the transmitter). This transmit power $P_s(m = 0) = P_s(m \rightarrow \infty)$ is also to be found in Figure 3 for $f_B = 1$ MHz and $\text{ld}(s) = 1$. It is recogniz-

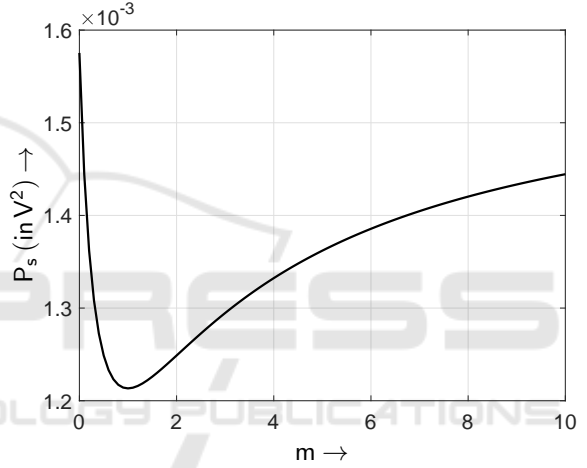

Figure 8: Transmit power P_s as a function of the equalization parameter m for an exemplary bit rate $f_B = 1$ MHz (parameters: $\ell = 2$ km, $s = 2$, $P_b = 1,5 \cdot 10^{-9}$ and $\Psi_0 = 10^{-12}$ V²/Hz).

able, that the transmit power P_s becomes minimal for $m = m_{\text{opt}} = 1$, i. e. for a uniform distribution of the linear equalization of the cable impact to transmitter and receiver: The optimum generalized transmit and receive filter transfer functions result in

$$H_{s\text{opt}}(f) = \frac{G_s(f)}{\sqrt{G_k(f)}} \quad (19)$$

and

$$H_{e\text{opt}}(f) = \frac{G_e(f)}{\sqrt{G_k(f)}} . \quad (20)$$

In Figure 9 the transmit power P_s is depicted as a function of the equalization parameter m for different constellation sizes s at a fixed bit rate f_B : It is recognizable that the minimum transmit power occurs for $m_{\text{opt}} = 1$ for all constellation sizes s . This result is also – vice versa – valid for different bit rates f_B and fixed constellation sizes s . Based on these results it is

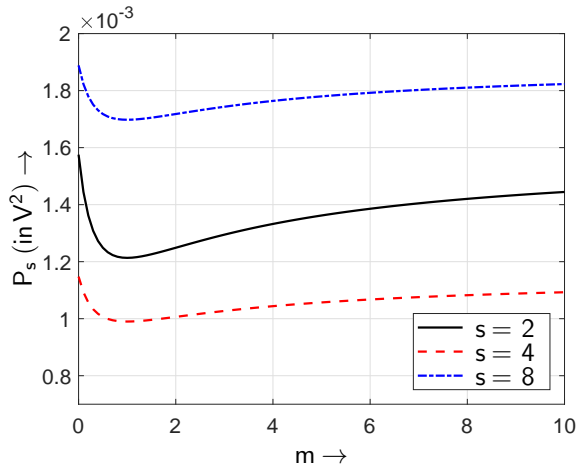

Figure 9: Transmit power P_s as a function of the equalization parameter m for an exemplary bit rate $f_B = 1$ MHz for different constellation sizes s (parameters: $\ell = 2$ km, $P_b = 1,5 \cdot 10^{-9}$ and $\Psi_0 = 10^{-12} \text{ V}^2/\text{Hz}$)

concluded, that the optimum equalization parameter $m_{\text{opt}} = 1$ is independent of the constellation size s and of the bit rate f_B .

The energies per bit $E_b = P_s/f_B$ can be shown in comparable diagrams and show a very similar behaviour, since they are scaled versions of the transmit power P_s – divided by a in each case constant bit rate f_B . Particularly, also the optimization with respect to a minimum energy per bit E_b then leads to the optimum equalization parameter $m_{\text{opt}} = 1$.

In conclusion of this optimization, the optimum equalization parameter $m_{\text{opt}} = 1$ is generally valid for all bit rates f_B and constellation sizes s —which is immediately obvious from Figure 8 and Figure 9. The energies per bit $E_b = P_s/f_B$ can be shown in comparable diagrams with a very similar behaviour, since they are scaled versions of the transmit power P_s – divided the bit rate f_B .

3.3.2 Results for Optimized Equalization Partitioning

The optimization of the equalization parameter m resulted in $m_{\text{opt}} = 1$, i. e. a uniform distribution of the linear cable equalization to transmitter and receiver. Therefore, the transmit power P_s and energy per bit E_b are compared as a function of the constellation size s again – for $m = 0$ (conventional transmission system with complete linear equalization in the receiver, as in section 2) and for $m = m_{\text{opt}} = 1$ (system with optimized linear equalization).

In Figure 10 the transmit power P_s and in Figure 11 the energy per bit E_b are shown as functions of the constellation size s for two bit rates for both equalization strategies, respectively.

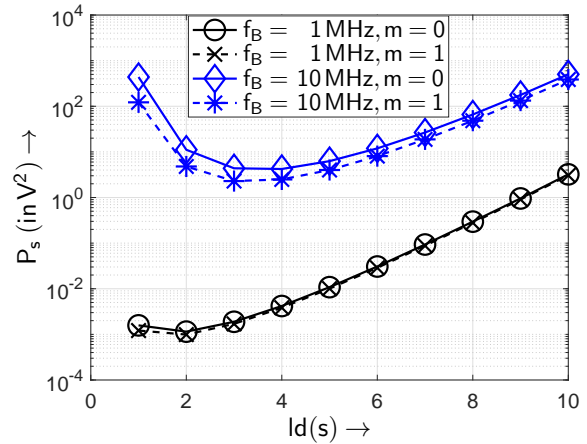

Figure 10: Transmit power P_s as a function of the constellation size s for two fixed bit rates f_B for $m = 0$ and $m = 1$ (parameters: $\ell = 2$ km, $P_b = 1,5 \cdot 10^{-9}$ and $\Psi_0 = 10^{-12} \text{ V}^2/\text{Hz}$).

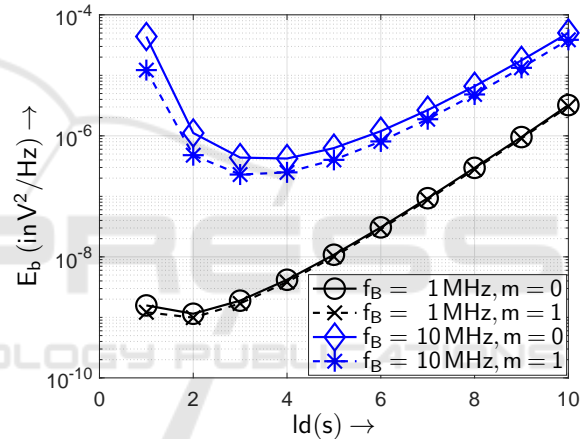

Figure 11: Energy per transmitted bit E_b as a function of the constellation size s for two fixed bit rates f_B for $m = 0$ and $m = 1$ (parameters: $\ell = 2$ km, $P_b = 1,5 \cdot 10^{-9}$ and $\Psi_0 = 10^{-12} \text{ V}^2/\text{Hz}$).

The results show, that there is a significant gain in terms of transmit power and energy per bit in particular at small constellation sizes, respectively. Towards larger constellation sizes the gain achievable by optimizing the equalization distribution becomes smaller. This behaviour originates from the fact that at smaller constellation sizes there is a higher symbol rate and thus a higher signal and filter bandwidth and the equalization has a greater impact than at larger constellation sizes, since the frequency range that has to be amplified by the equalizer to obtain an ISI-free signal is broader than at higher constellation sizes. Therefore the optimization of the equalization results in comparatively high improvements.

The curves of the energies per bit E_b and of the transmit powers P_s show again a very similar behaviour with respect to the constellation size s , since

each of the transmit power curves is divided (i. e., scaled) by a constant – but for each curve different – bit rate f_B to obtain the energy-per-bit functions.

The optimization of the equalization distribution to transmitter and receiver can lead to a significant decrease of the transmit power P_s or energy per bit E_b , respectively, since the optimum constellation sizes lie in tendency at lower values of s for practically relevant systems – and here the optimization of m shows large effects.

In Figure 12 and Figure 13 the transmit power P_s and the energy per bit E_b are shown as functions of the constellation size s for two exemplary bit rates for both equalization strategies, respectively – now for the shorter cable length of $\ell = 0,5$ km typical for FTTC access networks. The insights in principle resemble those obtained and discussed before for the cable of length $\ell = 2$ km – at correspondingly higher bit rates f_B on the shorter cable.

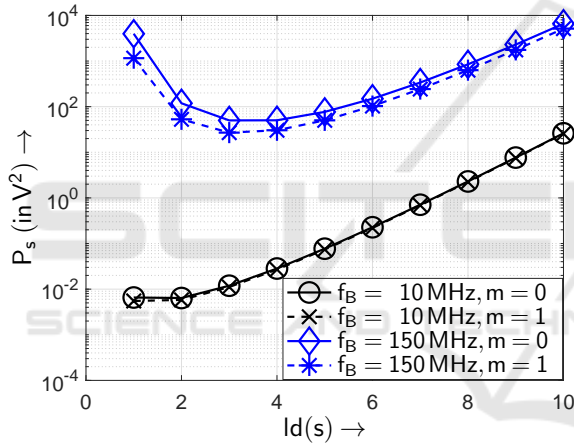

Figure 12: Transmit power P_s as a function of the constellation size s for two fixed bit rates f_B for $m = 0$ and $m = 1$ (parameters: $\ell = 0,5$ km, $P_b = 1,5 \cdot 10^{-9}$ and $\Psi_0 = 10^{-12} \text{ V}^2/\text{Hz}$).

3.3.3 Transmit Power and Energy per Bit Savings

The diagrams in Figures 10–13 show the results for transmit power and energy per bit in a logarithmic scale: Although improvements are recognizable it is hard to estimate the magnitude of the transmit power or energy per bit savings, respectively.

In order to make those savings visible, a relative saving in terms of transmit power or energy per bit is defined. Thereby, as a reference system the transmission system with two signalling levels and complete linear equalization in the receiver is utilized—as this is a conventional system with a simple and convenient implementation.

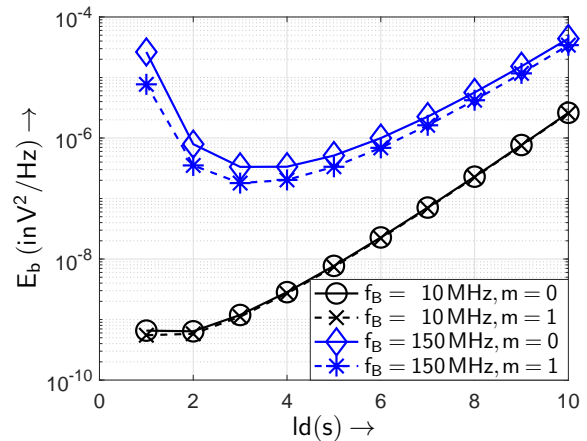

Figure 13: Energy per transmitted bit E_b as a function of the constellation size s for two fixed bit rates f_B for $m = 0$ and $m = 1$ (parameters: $\ell = 0,5$ km, $P_b = 1,5 \cdot 10^{-9}$ and $\Psi_0 = 10^{-12} \text{ V}^2/\text{Hz}$).

The relative transmit power or energy-per-bit savings are defined as

$$\epsilon(s) = 1 - \frac{P_s(s)}{P_{s2}} = 1 - \frac{E_b(s)}{E_{b2}} \quad (21)$$

The transmit power P_{s2} and the energy E_{b2} describe the respective transmit power or energy-per-bit values obtained for the reference system (with $s = 2$ and $m = 0$). For the transmit power and energy per bit functions the notation $P_s(s)$ and $E_b(s)$ is used, respectively, to emphasize their dependency on the variable constellation size s as compared to the values P_{s2} and E_{b2} for a single constellation size ($s = 2$). It is worth noting that it is irrelevant whether the savings are calculated by using the transmit power or the energy per bit according to (21)—as both are linked by the fixed bit rate f_B .

The parameter $\epsilon(s)$ shows the achievable savings very clearly. In Figure 14 and Figure 15 numerical results are presented for the two cases of the cable lengths ($\ell = 2$ km and $\ell = 0,5$ km): The power or energy-per-bit savings $\epsilon(s)$ are depicted as functions of the constellation size s . Only positive values of $\epsilon(s)$ are shown in Figure 14 and Figure 15 as real *savings* in terms of transmit power or energy per bit are depicted. According to (21) also negative results for $\epsilon(s)$ can occur, especially for large constellation sizes: Then the transmit power or energy per bit required at those respective constellation size is higher than that of the reference system – such results are not shown in the Figures 14 and 15.

In Figure 14 it becomes obvious for the longer cable ($\ell = 2$ km) that at the lower bit rate of $f_B = 1$ MHz approximately 25 % savings can be achieved by (only) using the optimum constellation size $s_{\text{opt}} = 4$. When staying at a (simple) system with $s = 2$ savings of

22% are registered if the equalization is uniformly distributed to transmitter and receiver ($m_{\text{opt}} = 1$). When combining both and the system operates at optimum constellation size ($s_{\text{opt}} = 4$) and optimal partitioning of the equalization ($m_{\text{opt}} = 1$) overall approximately 38% can be saved in terms of transmit power or energy per bit, respectively. At higher bit rates the achievable savings are much more significant, e. g. $> 90\%$ at a bit rate of $f_B = 10 \text{ MHz}$ for the given preconditions.

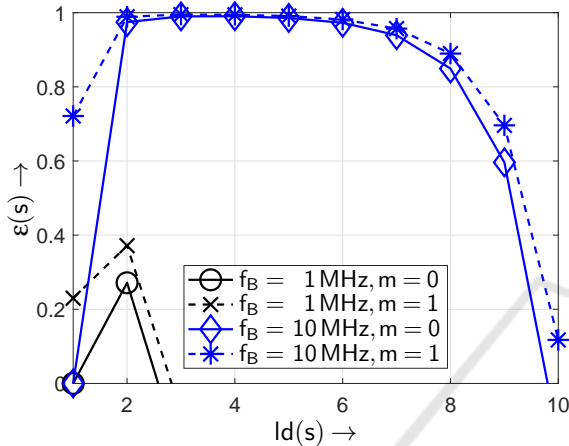

Figure 14: Relative power or energy-per-bit savings $\varepsilon(s)$, respectively, as a function of the constellation size s for two fixed bit rates f_B for $m = 0$ and $m = 1$ (parameters: $\ell = 2 \text{ km}$, $P_b = 1,5 \cdot 10^{-9}$ and $\Psi_0 = 10^{-12} \text{ V}^2/\text{Hz}$).

In Figure 15 the achievable savings for the shorter cable ($\ell = 0,5 \text{ km}$) are depicted: In tendency the results allow for comparable insights as discussed for the cable length of $\ell = 2 \text{ km}$ —now again at higher bit rates.

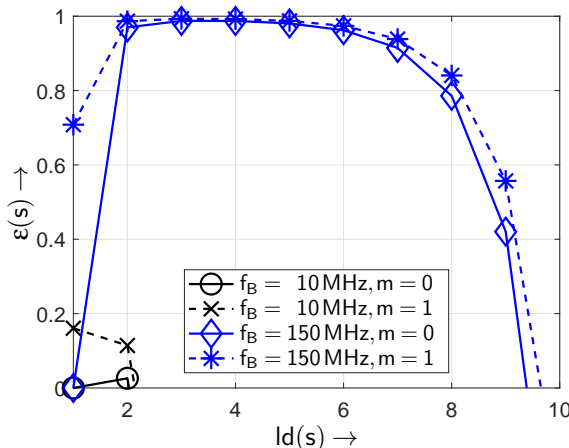

Figure 15: Relative power or energy-per-bit savings $\varepsilon(s)$, respectively, as a function of the constellation size s for two fixed bit rates f_B for $m = 0$ and $m = 1$ (parameters: $\ell = 0,5 \text{ km}$, $P_b = 1,5 \cdot 10^{-9}$ and $\Psi_0 = 10^{-12} \text{ V}^2/\text{Hz}$).

When considering the conventional two-level transmission ($s = 2$) with complete linear equalization in the receiver ($m = 0$) as reference, the savings of optimized transmission – with s_{opt} and m_{opt} – can be moderate in a range of $15 \dots 40\%$ at the lower bit rates and they can become as high as $> 80\%$ for the higher bit rates at the different cable lengths.

The achievable relative savings in terms of transmit power and energy per bit depend on the concrete values of the given parameters, in particular cable length ℓ (and characteristic cable frequency f_0) and bit rate f_B , i. e., on the interrelationship of signal bandwidth and low-pass characteristic of the cable. The achievable improvements by using optimum constellation sizes and optimal partitioning of the equalization to transmitter and receiver in terms of transmit power and energy per bit are especially high in cases when the transmission system operates at high bit rates in relation to the band limitation induced by the cable's low pass characteristic.

In real communication networks a vast multitude of transmission links – in particular in access networks – is established and operated: The optimization of those transmission systems with regard to degrees of freedom in design and adaptation processes provides substantial overall power and energy saving potential.

4 CONCLUSION

Power and energy efficiency of baseband transmission in linearly equalized copper cable channels have been studied. In a first part, the investigations have focused on the dependency of the transmit power P_s and the energy per bit E_b on the constellation size s —which represents a degree of freedom in the design of transmission systems. The bit rate f_B and the transmission quality (P_b) as well as the channel characteristics of cable (ℓ , f_0) and noise (Ψ_0) have been considered preconditions.

The transmit power P_s and the energy per bit E_b depend on the constellation size s . There is an optimum constellation size s_{opt} where the transmit power or energy per bit show a minimum. The optimum constellation size s_{opt} depends on the interrelationship between signal bandwidth and cable low-pass characteristic, i. e., the interdependency between f_B , ℓ (and f_0) is important.

In a second part, the partitioning of the linear equalization has been identified to be another degree of freedom in transmission engineering of cable transmission systems: The related optimization showed that a uniform distribution of the equalization to trans-

mitter and receiver results in a minimum transmit power P_s or energy per bit E_b , respectively, with respect to the equalization parameter m .

Overall significant transmit power or energy-per-bit savings can be achieved as compared to conventional two-level systems with complete linear equalization at the receiver side. When assuming already optimized constellation sizes the optimization of the equalization enables a further lowered power and energy demand.

The optimization of the constellation size and the equalization in wired transmission systems is an important pre-requisite for energy-efficient transmission. It can help to operate communication networks sustainably since such networks usually consist of a large multitude of various kinds of transmission links. Furthermore it may allow for energy-efficient load-adaptive transmission by adapting the transmission capabilities to temporally fluctuating traffic demands.

For future work it is very interesting to analyze the computational complexity that is necessary to perform the optimization and to control the settings for the transmission system considered in this contribution: Besides the transmit power – and the energy per bit resulting thereof – that is needed for the pure transmission additional power and energy is necessary to control the system and its individual elements and blocks to operate at optimum constellation size and optimized partitioning of the equalization.

ACKNOWLEDGEMENTS

The authors thank the anonymous reviewers for helpful hints and suggestions that lead to improvements of the paper.

REFERENCES

- Agrell, E. and Karlsson, M. (2009). Power-Efficient Modulation Formats in Coherent Transmission Systems. *Journal on Lightwave Technology*, 27(22):5115–5126.
- Anderson, J. B. (2005). *Digital Transmission Engineering*. IEEE Press; John Wiley & Sons, Piscataway, NJ, 2nd edition.
- Bolla, R., Bruschi, R., Davoli, F., and Cucchietti, F. (2011). Energy Efficiency in the Future Internet: A Survey of Existing Approaches and Trends in Energy-Aware Fixed Network Infrastructures. *IEEE Communications Surveys & Tutorials*, 13(2):223–244.
- Kilper, D., Guan, K., Hinton, K., and Ayre, R. (2012). Energy Challenges in Current and Future Optical Transmission Networks. *Proceedings of the IEEE*, 100(5):1168–1187.
- Kilper, D. C., Atkinson, G., Korotky, S. K., Goyal, S., Vetter, P., Suvakovic, D., and Blume, O. (2011). Power Trends in Communication Networks. *IEEE Journal of Selected Topics in Quantum Electronics*, 17(2):275–284.
- Kilper, D. C., Neilson, D., Stiliadis, D., Suvakovic, D., and Goyal, S. (2010). Fundamental Limits on Energy Use in Optical Networks. In *36th European Conference and Exhibition on Optical Communication*, pages 1–6.
- Lambert, S., Van Heddeghem, W., Vereecken, W., Lannoo, B., Colle, D., and Pickavet, M. (2012). Worldwide Electricity Consumption of Communication Networks. *Optics Express*, 20(26):B513–B524.
- Lange, C. and Ahrens, A. (2021). Power and Energy Efficiency Optimization of Baseband Transmission Links. In *Signal Processing Symposium (SPSymo)*, pages 147–152, Lodz (Poland).
- Lange, C., Kosiankowski, D., Weidmann, R., and Gladisch, A. (2011). Energy Consumption of Telecommunication Networks and Related Improvement Options. *IEEE Journal of Selected Topics in Quantum Electronics*, 17(2):285–295.
- Lange, C., Preuschaft, J., Braune, M., and Gieschen, N. (2008). Migration from Current DSL-Based Architectures to Future-Proof Pure Optical Access Networks. In *13th European Conference on Networks & Optical Communications (NOC)*, pages 152–159, Krems (Austria).
- McCune, E. (2013). This Emperor Has No Clothes? *IEEE Microwave Magazine*, 14(4):48–62.
- Pickavet, M., Vereecken, W., Demeyer, S., Audenaert, P., Vermeulen, B., Develder, C., Colle, D., Dhoedt, B., and Demeester, P. (2008). Worldwide Energy Needs for ICT: The Rise of Power-Aware Networking. In *2008 2nd International Symposium on Advanced Networks and Telecommunication Systems*, pages 1–3.
- Proakis, J. G. and Salehi, M. (2008). *Digital Communications*. McGraw-Hill, Boston; New York; San Francisco, 5th edition.
- Shumate, P. W. (2008). Fiber-to-the-Home: 1977–2007. *Journal of Lightwave Technology*, 26(5):1093–1103.
- Sklar, B. (2001). *Digital Communications*. Prentice Hall, Upper Saddle River, NJ, 2nd edition.
- Tsiropoulou, E. E., Katsinis, G. K., and Papavassiliou, S. (2012). Distributed Uplink Power Control in Multi-service Wireless Networks via a Game Theoretic Approach with Convex Pricing. *IEEE Transactions on Parallel and Distributed Systems*, 23(1):61–68.
- Tucker, R. S. (2011a). Green Optical Communications Part I: Energy Limitations in Transport. *IEEE Journal of Selected Topics In Quantum Electronics*, 17(2):245–260.
- Tucker, R. S. (2011b). Green Optical Communications Part II: Energy Limitations in Networks. *IEEE Journal of Selected Topics In Quantum Electronics*, 17(2):261–274.