

# A Hierarchical Decomposition Approach for the Optimal Design of a District Cooling System

Bingqian Liu<sup>1</sup><sup>a</sup>, Côme Bissuel<sup>1</sup><sup>b</sup>, François Courtot<sup>2</sup>, Céline Gicquel<sup>3</sup><sup>c</sup> and Dominique Quadri<sup>3</sup>

<sup>1</sup>EDF R&D, Chatou, France

<sup>2</sup>EDF R&D China, China

<sup>3</sup>Université Paris Saclay, LRI, France

**Keywords:** Local Energy System Design, Mixed-integer Linear Programming, Branch & Bound, Hierarchical Decomposition.

**Abstract:** A district cooling system is a centralized cooling supply system providing air conditioning to a set of buildings located in the same district. Designing and sizing such a system is very complex, as both the initial construction cost and the operation cost of the cooling system during its entire life must be considered. We first propose a modeling approach aiming at formulating this combinatorial optimization problem as a mixed-integer linear program of tractable size. We then extend a previously published hierarchical decomposition technique in order to find the optimal solution in an efficient way. Finally, we provide preliminary computational results based on a real-life case study located in China.

## 1 INTRODUCTION

A district cooling system (DCS) is a centralized cooling supply system. It consumes electricity to cool down water and distributes it through an underground pipe network to the buildings in the district to provide them with air conditioning. DCSs usually are highly energy-efficient cooling systems. Thus, according to the Electrical and Mechanical Services Department of Hong Kong EMSD (2020), using DCSs instead of traditional air-cooled air-conditioning systems results in energy savings of 35%. DCSs also compare well with individual water-cooled air-conditioning systems using cooling towers as the energy savings may be up to 20%. Furthermore, this lower energy consumption leads to lower greenhouse gas emissions, which helps reduce the environmental impact of the system.

Designing a DCS involves choosing the type and number of chillers to be installed as well as the ice storage capacity. These decisions should take into account not only the construction costs, but also the operation costs of the system during its whole lifetime. Computing these operation costs is a chal-

lenging problem. Namely, the demand for cooling power is highly variable and features a daily, weekly and yearly seasonality together with random variations. Moreover, due to technical reasons owing to the chillers, these operations costs are not at all proportional to the produced cooling power. Thus, in order to accurately estimate them, a detailed schedule describing, on a hourly basis, the on/off status and the load allocation of each chiller should be built for an horizon spanning a whole year. Furthermore, the deployment of a district cooling system is usually not a one-shot decision but rather a process in which investment decisions are made step by step, following the development of the district and the upward trend of the average demand over the years. This implies that a multi-phase strategic deployment plan should be built.

This optimization problem can be formulated as a mixed-integer program. However, its resolution poses several difficulties. The first one comes from the non-linearity of the chillers' performance curves. These performance curves give, for each chiller, the amount of electricity consumed as a function of the amount of produced cooling power and thus play a key role in the estimation of the system operation costs. Second, the need to simultaneously build a multi-year phasing plan and a detailed operational schedule for each day of the planning horizon leads to the formu-

<sup>a</sup> <https://orcid.org/0000-0001-7493-4277>

<sup>b</sup> <https://orcid.org/0000-0002-5430-3168>

<sup>c</sup> <https://orcid.org/0000-0002-2719-7443>

lation of a huge mathematical program, which cannot be solved directly by current mathematical programming solvers. Finally, the use of classical decomposition methods, such as the Benders' decomposition approach, is not straightforward as it would imply sub-problems involving binary and/or integer decision variables. The mixed-integer program modeling the problem is thus computationally intractable as such.

However, solution approaches exploiting the natural hierarchy between decisions relative to the system design and decisions relative to the daily operation schedules have been investigated in several works. Weber et al. (2007) thus studied the optimal design of a multi-energy system. A two-level optimization method is implemented. The master optimization level explores the set of possible system designs with the use of an evolutionary algorithm. For each considered system design, the slave optimization level calculates the optimal cost by linear programming. This approach does not provide a guaranteed optimal solution and the formulation of the slave sub-problems as linear programs does not allow to accurately model the way the system operates in practice. Iyer and Grossmann (1998) also use a bi-level method to optimize the choice and sizes of equipment for utility systems. At the design optimization level, the problem aims at fixing the system infrastructure. All binary decision variables relative to the operation schedules are removed from this master problem. Each time a potential infrastructure is found, the operation optimization level solves a set of single-period scheduling sub-problems taking the current system infrastructure as input data. Design cuts are used to tighten the gap between the solutions found at both levels. Yokoyama et al. (2015) consider local energy supply systems and propose a customized Branch & Cut algorithm exploiting the hierarchical relationship between the design and operation decision variables of the mathematical program. The upper level problem corresponds to the initial optimization problem in which all operational integer and binary variables are kept but relaxed to be continuous. Each time an integer feasible solution is found at the upper level, a sequence of single-period independent operation sub-problems is solved to check the feasibility and value of the current design solution. Note that Iyer and Grossmann (1998) and Yokoyama et al. (2015) both consider a single-phase variant of the problem, i.e. a variant in which all design decisions are one-shot decisions. Moreover, their design infrastructure did not allow short-term intra-day energy storage. This allows them to consider single-period (i.e. one-hour) scheduling sub-problems rather than multi-

period (i.e. 24-hour) scheduling sub-problems, which significantly decreases the size of these sub-problems.

In the present work, we propose a solution approach for the optimal design, over a multi-phase investment horizon, of a local district cooling system in which intra-day ice storage is allowed. This approach relies on three key elements. First, we seek to reduce the size of the initial optimization problem. We thus consider a deployment plan involving a limited number of phases, some of which spanning several years. Moreover, we use the clustering approach described in Zatti et al. (2019) to select a small set of typical days to represent with the smallest possible loss of accuracy the various conditions under which the system will be operated. Second, we build a piecewise linear approximation of the performance curves of each chiller and propose a way to exploit their convexity to reduce the size of the formulation of the operation scheduling sub-problems. This results in the formulation of a large-size mixed-integer linear program (MILP). Thirdly, we develop an exact solution algorithm based on the hierarchical decomposition method recently proposed by Yokoyama et al. (2015) to solve this MILP.

The remaining of the paper is organized as follows. Section 2 gives a detailed description of the problem under study. In Section 3, the approximation of the nonlinear performance curves and the clustering method used to identify typical days are first presented. The formulation of the optimization problem as an MILP is then provided. Section 4 introduces the hierarchical decomposition algorithm used to solve this MILP. In Section 5, the results of our preliminary computational experiments based on a real-life case study in China are reported.

## 2 PROBLEM PRESENTATION

Before the actual construction of a cooling system, a thorough and reliable system design is necessary. The system design consists in selecting the appropriate chillers and in sizing the ice storage capacity to be installed. The main objective is to design a system which will be able to meet the clients' cooling demand at all time while leading to the lowest long-term investments and operation costs.

### 2.1 Resources

A chiller is a machine that removes heat from a liquid by using a variety of techniques such as vapor-compression. We consider here electric-powered chillers which are used to cool water. These chillers

can be classified into two main categories depending on their functionality. Standard chillers (denoted by STDC) only produce cooling power to satisfy the instantaneous demand of the customers. Ice chillers (denoted by ICEC) have two distinct operating modes: they either produce cooling power, but usually with a lower efficiency than the one of a STDC, or they produce ice. This ice can be stored for a few hours in an ice storage tank and be melted afterwards to provide cooling power.

Within each category of chillers (STDC or ICEC), there are chillers with different production capacity levels. Each level corresponds to a predefined production range, i.e. to a minimum and maximum cooling power (or ice) it can provide per hour when turned on, and to a set of performance curves. Namely, the energy consumption of a chiller is a function of the produced cooling power and the ambient temperature. We thus have performance curves representing the relation between the electric power consumed by a chiller and the cooling power (or ice) produced under different ambient temperatures. Note that these performance curves are usually not linear. In the present paper, we will focus on the case of non-linear convex performance curves. The more general non-convex case is left for future work.

Another key resource in the system is the ice storage tank. This tank is linked to all the ice chillers of the system, can store the produced ice for a few hours and release it afterwards to produce cooling power. It has a maximal storage capacity, which can be chosen within a predefined range.

See Figure 1 for a schematic representation of the studied DCS.

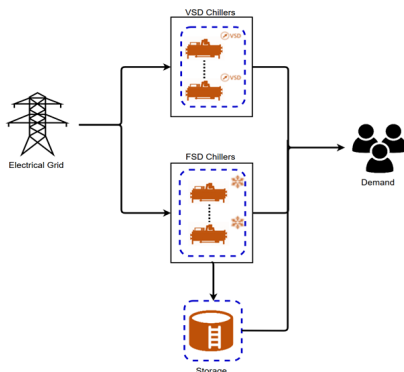

Figure 1: Overview of a DCS.

## 2.2 Cooling Demand

As highlighted in the introduction, the cooling demand to be satisfied by the local cooling system is highly variable. First, the demand for cooling power

varies throughout the day and is usually much higher at daytime than at night. There are also weekly and yearly variations: the demand pattern of a weekday thus significantly differs from the one observed during the week-end and the total daily demand varies during the year, in particular with the summer and winter seasons. Finally, during the first operating years of the system, the demand displays a general upward trend as new clients join the district cooling system. After this initial period, the demand usually gets more or less stable for the rest of the system lifetime.

Parts of these demand variations display a seasonal pattern and are thus to some extent predictable. However, the demand is also subject to the presence of extreme weather conditions which are difficult to anticipate. Days with such effects should be considered separately from others. This translates in particular into the existence of extreme days, i.e. days in which the total daily or hourly demand is exceptionally low or high as compared to its usual value.

A key requirement is that the system should be able to satisfy the demand for cooling power at all time, whatever the hour of the day, the day in week or the season. In particular, it should be able to satisfy all the demand, even if it is exceptionally low or high.

## 2.3 Electricity Supply

The chillers are powered by electricity bought from an external utility provider.

Similar to the cooling power demand, the electricity price displays daily, weekly and yearly variations. In particular, within a day, three types of periods, termed peak, flat and valley periods, can be distinguished. They correspond respectively to the highest, intermediate or lowest prices. Peak periods are usually at noon and in the evening, the valley periods at night and early in the morning and the rest of the day corresponds to flat periods. These price variations can be exploited to reduce the total energy cost, e.g. by producing ice at night when the demand for cooling power is low and the electricity rather cheap, storing it for a few hours and releasing ice to produce cooling power at daytime when the demand is high and the electricity more expensive.

Moreover, in many cases, the contract with the electricity provider includes a maximum allowed instantaneous power consumption from the grid. This upper limit is set contractually at the beginning of each year. The corresponding cost, called the contract fee, is proportional to the subscribed maximum power. This contract fee differs from the electricity consumption cost. It namely buys the permission of

consuming electric power and sets an upper limit (expressed in kW) to this instantaneous consumption. In contrast, the electricity consumption cost depends on the total amount of consumed electric energy which is expressed in kWh.

## 2.4 Costs

The total cost of the system comprises two main parts: the design cost and the operation cost.

The design cost is the sum of the purchase, installation and maintenance costs of the chillers and ice storage tank, and of the annual contract fee. Once the cooling system design is chosen, this cost will be determined.

The operation cost corresponds to the cost of the electricity consumed when the system operates to satisfy the customers' cooling demand. Due to the non-linearity of the chillers' performance curves, this cost is not proportional to the amount of produced cooling power. In order to accurately estimate it, we need to build a detailed production schedule for each day of the planning horizon using a fine time discretization.

The objective of this optimization problem is to find a system design which can minimize the sum of the design and operation costs. Therefore, the best system design as well as the most cost-efficient daily optimal operation strategy corresponding to the chosen system should be searched.

# 3 PROBLEM MODELING

## 3.1 Selection of Typical Days

The huge size of the optimization problem, which combines both long-term design and detailed (usually with an hourly timestep) production scheduling decisions, makes it computationally intractable. A possible way of getting over this difficulty consists in selecting, within the available data, a subset of typical days and extreme days which will represent the various conditions under which the system will be operated. These days should be carefully chosen as they will have a strong impact on the selection of the chillers and sizing of the ice storage tank.

This can be done by solving a clustering problem such as the k-medoid problem. In our case, this problem consists in partitioning the set of days belonging to the available historical time series into groups or clusters and in choosing one member (i.e. one day) in each cluster to represent it so as to minimize the total Euclidian distance between each day in the time series and its representative. In this work, we use the

extension of the k-medoid problem proposed by Zatti et al. (2019) to select typical days for optimizing the design of our system.

## 3.2 Piecewise Linear Approximation of the Performance Curves

The performance curves of a given type of chiller are supplied by its manufacturer. They give, for a discrete set of values of the ambient temperature, the amount of electric energy consumed as a function of the output cooling power. Their non-linearity is a major source of difficulty for the resolution of our optimization problem. We thus propose to build a piecewise linear approximation of each curve.

This approximation is built using the following procedure. We first fix a predefined number of breakpoints in the piecewise linear approximation to be built. We then determine the coordinates of these breakpoints by heuristically solving a small non-linear optimization problem aiming at minimizing the distance between the approximate performance curve and the actual one.

Then, for each hour of each selected day, we use historical data about the average ambient temperature to determine the approximate performance curve that should be used to compute the energy consumption of each type of chiller during each time period.

## 3.3 Notation

The problem modeling relies on a three-level time discretization. The forecast lifetime of the system is first divided into a set of phases or investment periods, each one typically spanning one or several years: we assume that design decisions such as the installation of a new chiller can be only made at the beginning of a new phase. Let  $\Phi$  be the number of considered phases. Within each considered phase, the various conditions under which the system will be operated will be represented by a number of preselected typical days and extreme days. We denote by  $\mathcal{D}_\phi$  the set of typical days and extreme days used to represent the various daily demand patterns during phase  $\phi \in \{1, \dots, \Phi\}$ . Each selected day  $d$  of phase  $\phi$  has a weight  $w_{\phi,d}$  corresponding to the number of days it represents, i.e. to the number of days of the original historical time series which were assigned to the cluster it belongs to. Finally, in order to describe the intraday variations of the cooling demand and electricity price, each selected day is divided into 24 one-hour periods. For the sake of readability, in what follows, we use the letter  $t$  to represent the time period  $(\phi, d, h)$  corresponding to phase  $\phi$ , selected day  $d$  and hour  $h$ .



Let  $Dem_t$  (resp.  $EP_t$ ) represent the cooling power demand (resp. the electricity price) at time period  $t$ .

There are different types of chillers that may be installed in the system. Each type of chiller  $m = (p, l)$  can be described by its category  $p \in \{STDC, ICEC\}$  (i.e. standard or ice chiller), which defines the list of commodities  $C_p \subset \{COLD, ICE\}$  it can produce, and its production capacity level  $l \in \{1, \dots, L_p\}$ . Let  $\mathcal{M} = \{(p, l) | p \in \{STDC, ICEC\}, l \in \{1, \dots, L_p\}\}$  be the set of all chiller types. We denote by  $P_{m,c}^{min}$  and  $P_{m,c}^{max}$  the minimum and maximum output power of a chiller of type  $m = (p, l)$  producing commodity  $c \in C_p$ . As explained above, the performance curve of a chiller of type  $m$  producing commodity  $c$  at time period  $t$  is approximately represented by a piecewise linear function comprising  $B_{t,m,c}$  breakpoints. Let  $a_{t,m,c,b}$  and  $o_{t,m,c,b}$  be the abscissa and ordinate of breakpoint  $b$  of this piecewise linear function.

With respect to the design of the system, some restrictions have to be taken into account. There is namely an upper bound  $SD_m^{max}$  to the total number of chillers of type  $m$  that may be installed in the system. The total ice storage capacity built in the system should also stay below a maximum allowed capacity  $StoC^{max}$ . Moreover, in terms of design costs, we denote by  $FC_{\phi,m}$  the fixed cost of investing in a chiller of type  $m$  at phase  $\phi$ . This fixed cost comprises the construction or capital expenditure cost at phase  $\phi$  and the total maintenance cost of the chiller over its whole lifetime (from phase  $\phi$  to phase  $\Phi$ ). Regarding the ice storage capacity, the installation cost is broadly proportional to the installed capacity. We denote by  $LC_{\phi}$  the cost of building one unit of ice storage capacity at phase  $\phi$ . Finally, the unit subscription cost for the maximum instantaneous power is assumed denoted by  $SC_{\phi}$ . Note that all the design costs  $FC_{\phi,m}$ ,  $LC_{\phi}$  and  $SC_{\phi}$  are assumed uniform along each deployment phase.

### 3.4 Variables

In order to model the problem as a mixed-integer linear program, we introduce two sets of decision variables.

The first set of decision variables corresponds to long-term design decisions which will determine the general structure of the system, together with the multi-year phasing plan. Thus,  $\mathbf{SD}_{\phi,m}$  represents the integer number of chillers of type  $m$  to be installed at the beginning of phase  $\phi$ ,  $\mathbf{StoC}_{\phi}$  is a continuous variable representing the ice storage capacity built at the beginning of phase  $\phi$  and  $\mathbf{C}_{\phi}$  is the maximum allowed electric power consumption contracted with the electricity provider for phase  $\phi$ . These variables will be

referred to as design decision variables in what follows.

The second set of decision variables are used to build the operational schedule for each selected day  $d \in \mathcal{D}_{\phi}$  of each phase  $\phi$ . In the present work, we will focus on the special case in which all performance curves of the chillers are convex. This assumption allows us to use aggregate performance curves (see Appendix for more detail about this) and to build the schedule while considering, in each period  $t$ , aggregate scheduling variables, i.e. variables pertaining to the set of chillers of identical type producing the same commodity  $c$  during  $t$ , instead of disaggregate scheduling variables, i.e. variables pertaining to the status and output of each individual chiller installed in the system in period  $t$ .

We thus introduce  $\mathbf{S}_{t,m,c}$  the integer number of chillers of type  $m$  producing commodity  $c$  during period  $t$ ,  $\mathbf{P}_{t,m,c}$  the total amount of commodity  $c$  produced by the chillers of type  $m$  during period  $t$  and  $\mathbf{Q}_{t,m,c}$  the total electric consumption of the chillers of type  $m$  producing commodity  $c$  in period  $t$ . Moreover, in order to monitor the ice storage and release, we define  $\mathbf{STO}_t$  the amount of ice stored in the tank at the beginning of period  $t$  and  $\mathbf{R}_t$  the amount of ice released during  $t$ . These decisions will be referred to as operation decision variables in what follows.

### 3.5 Objective Function

We seek to minimize the sum of the design and operation costs of the system over its whole lifetime. The objective function of the mathematical program is thus given by:

$$\min \sum_{\phi=1}^{\Phi} \alpha_{\phi} \left[ \sum_{m \in \mathcal{M}} FC_{\phi,m} \mathbf{SD}_{\phi,m} + LC_{\phi} \mathbf{StoC}_{\phi} + SC_{\phi} \mathbf{C}_{\phi} + \sum_{d \in \mathcal{D}_{\phi}} w_{\phi,d} \sum_{h=0}^{23} \sum_{m \in \mathcal{M}} \sum_{c \in C_p} EP_{\phi,d,h} \mathbf{Q}_{\phi,d,h,m,c} \right] \quad (1)$$

where  $\alpha_{\phi}$  is the actualization rate for the costs incurred in phase  $\phi$ .

### 3.6 Constraints

Similar to the decision variables, the constraints of the mathematical model can be classified into two groups: design constraints and operation constraints.

#### 3.6.1 Design Constraints

Design constraints are constraints involving only design decision variables. In the present case, for each

type of chiller  $m \in \mathcal{M}$ , we have the following constraint which states that the total number of chillers of type  $m$  included in the DCS should be less than the maximum number of chillers of this type allowed.

$$\sum_{\varphi=1}^{\Phi} \mathbf{SD}_{\varphi,m} \leq \mathbf{SD}_m^{\max} \quad (2)$$

Similarly, Constraint (3) makes sure that the total ice storage capacity of the system stays below the maximum allowed value.

$$\sum_{\varphi=1}^{\Phi} \mathbf{StoC}_{\varphi} \leq \mathbf{StoC}^{\max} \quad (3)$$

### 3.6.2 Operation Constraints

Operations constraints are constraints involving operation decision variables, together with design variables in some cases. For each time period  $t$ , we have the following set of constraints.

**Demand Satisfaction.** The demand for cooling power must be satisfied at all time. This can be done either by directly using the cooling power produced by the currently turned on chillers and by releasing some ice from the ice storage tank.

$$\sum_{m \in \mathcal{M}} \mathbf{P}_{t,m,\text{COLD}} + \mathbf{R}_t = \mathbf{Dem}_t \quad (4)$$

**Chillers.** Regarding the chillers, two sets of constraints should be introduced in the formulation.

First, for each type of chiller  $m \in \mathcal{M}$ , the total number of operating (i.e. turned on) chillers should be less than the number of chillers currently installed in the DCS:

$$\sum_{c \in \mathcal{C}_p} \mathbf{S}_{t,m,c} \leq \sum_{\varphi=1}^{\Phi} \mathbf{SD}_{\varphi,m} \quad (5)$$

Second, for each type of chiller  $m \in \mathcal{M}$  and each commodity  $c \in \mathcal{C}_p$  it can produce, the total amount produced by the turned on chillers should stay within the allowed production range:

$$\mathbf{P}_{t,m,c} \leq P_{m,c}^{\max} \mathbf{S}_{t,m,c} \quad (6)$$

$$\mathbf{P}_{t,m,c} \geq P_{m,c}^{\min} \mathbf{S}_{t,m,c} \quad (7)$$

**Electric Consumption.** As shown in Appendix, when the chillers' performance curve are convex, the aggregate electric consumption of the set of chillers corresponding to a given type  $m = (p, l) \in \mathcal{M}$  and producing commodity  $c \in \mathcal{C}_p$  in  $t$  belongs to the epigraph of a piecewise linear function defined by breakpoints  $b = 1 \dots B_{t,m,c}$ . We thus have, for each  $m = (p, l) \in \mathcal{M}$ , each  $c \in \mathcal{C}_p$  and each  $b \in \{1 \dots B_{t,m,c} - 1\}$ , the following inequality:

$$\mathbf{Q}_{t,m,c} \geq s_{t,m,c,b} \mathbf{P}_{t,m,c} + c_{t,m,c,b} \mathbf{S}_{t,m,c} \quad (8)$$

where  $s_{t,m,c,b} = \frac{o_{t,m,c,b+1} - o_{t,m,c,b}}{a_{t,m,c,b+1} - a_{t,m,c,b}}$  is the slope of the line segment between breakpoints  $b$  and  $b + 1$  and  $c_{t,m,c,b} = o_{t,m,c,b} - s_{t,m,c,b} a_{t,m,c,b}$  the corresponding constant value. Note that Constraints (8) accurately compute the electric consumption of a set of chillers only if the corresponding performance curve is convex. The more general case of non-convex performance curve is left for future work.

Moreover, the total amount of electric energy consumed in period  $t$  is limited by an upper bound,  $\mathbf{C}_{\Phi} \times 1$  hour, which represents the maximum instantaneous power  $\mathbf{C}_{\Phi}$  contracted with the electricity provider times the duration of the period (one hour):

$$\sum_{m \in \mathcal{M}} \sum_{c \in \mathcal{C}_p} \mathbf{Q}_{t,m,c} \leq \mathbf{C}_{\Phi} \quad (9)$$

**Ice Storage.** Regarding the ice storage, three constraints should be considered in each time period.

First, the amount of ice stored in the tank should not exceed the current storage capacity.

$$\mathbf{STO}_t \leq \sum_{\varphi=1}^{\Phi} \mathbf{StoC}_{\varphi} \quad (10)$$

Second, the amount of ice released during the period should be less than the amount stored in the tank at the beginning of the period.

$$\mathbf{R}_t \leq \mathbf{STO}_t \quad (11)$$

Third, the evolution of the ice inventory stored in the tank should comply with inventory balance equations. We first consider time periods  $(\phi, d, h)$  corresponding to  $h \in \{0 \dots 22\}$  as the last hour of the day  $h = 23$  requires a special treatment. For each period  $(\phi, d, h)$  such that  $h \in \{0 \dots 22\}$ , we have:

$$\begin{aligned} \mathbf{STO}_{\phi,d,h} + \sum_{l=1}^{L_{ICEC}} \mathbf{P}_{\phi,d,h,ICEC,l,ICE} - \mathbf{R}_{\phi,d,h} \\ = \mathbf{STO}_{\phi,d,h+1} \end{aligned} \quad (12)$$

Constraints (12) state that the amount of ice stored at the beginning of hour  $h + 1$ ,  $\mathbf{STO}_{\phi,d,h+1}$ , is equal to

the amount of ice already stored at the beginning of hour  $h$ ,  $\mathbf{STO}_{\phi,d,h}$ , plus the total amount of ice produced by the ice chillers of various capacity levels during  $h$  minus the ice melted during  $h$ . Note that the loss of ice stored in the tank during a day is assumed to be negligible.

Moreover, for each time period  $(\phi, d, h)$  corresponding to  $h = 23$ , i.e. to the last hour of the selected day, we have the following inventory balance equation:

$$\begin{aligned} \mathbf{STO}_{\phi,d,23} + \sum_{l=1}^{L_{ICEC}} \mathbf{P}_{\phi,d,23,ICEC,l,ICE} - \mathbf{R}_{\phi,d,23} \\ = \mathbf{STO}_{\phi,d,0} \end{aligned} \quad (13)$$

Namely, in practice, the entering inventory of a given day in the scheduling horizon is imposed by the leaving inventory of the previous day. In our case, we do not consider each individual day of the scheduling horizon but rather a number of representative days which will not necessarily occur successively in practice. We thus impose that the leaving ice inventory of a selected day  $d$ , computed as  $\mathbf{STO}_{\phi,d,23} + \sum_{l=1}^{L_{ICEC}} \mathbf{P}_{\phi,d,23,ICEC,l,ICE} - \mathbf{R}_{\phi,d,23}$  should be equal to the entering inventory of the same selected day  $d$ ,  $\mathbf{STO}_{\phi,d,0}$ . This might be understood as the fact that the selected day  $d$  will be cyclically repeated  $w_{\phi,d}$  times in the simplified scheduling horizon used in our optimization problem for phase  $\phi$ .

## 4 SOLUTION APPROACH

The mathematical program (1)-(13) formulated in Section 3 displays a particular structure. We namely have a set of independent sub-problems. Each of them corresponds to optimizing the detailed schedule for a single selected day  $d$  of a single phase  $\phi$  and involves operation variables and operation constraints relative only to the corresponding day  $(\phi, d)$ . These independent sub-problems are linked together by the design variables.

A Benders decomposition approach might seem appropriate for a problem displaying such a structure in which coupling variables link together a set of independent sub-problems. However, its application is not straightforward here as each sub-problem involves integer variables (namely variables  $\mathbf{S}_{t,m,c}$ ) and Benders decomposition algorithms rely on the strong duality theory to generate Benders cuts. We thus investigate another hierarchical decomposition approach recently proposed by Yokoyama et al. (2015).

### 4.1 Hierarchical Structure of the Problem

To better highlight the hierarchical structure of the problem and more easily explain the decomposition approach, we will use a compact formulation of the problem.

Vector  $\mathbf{x}$  represents in a synthetic way the design variables relative to all phases, i.e.  $\mathbf{x} = (\mathbf{SD}_1, \mathbf{StoC}_1, \mathbf{C}_1, \dots, \mathbf{SD}_{\phi}, \mathbf{StoC}_{\phi}, \mathbf{C}_{\phi})$ . Vector  $\mathbf{y}_k$  represents all the continuous operation variables relative to a given selected day  $k = (\phi, d)$  whereas  $\mathbf{z}_k$  stands for all the binary or integer variables relative to day  $k$ .

With this notation, Problem (1)-(13) can be formulated as follows.

$$\min Z = f_0(\mathbf{x}) + \sum_{k \in \mathcal{K}} f_k(\mathbf{y}_k, \mathbf{z}_k) \quad (14)$$

$$h(\mathbf{x}) \leq 0 \quad (15)$$

$$g_k(\mathbf{x}, \mathbf{y}_k, \mathbf{z}_k) \leq 0 \quad \forall k \in \mathcal{K} \quad (16)$$

$$\mathbf{x} \in \mathbb{Z}^v \quad (17)$$

$$\mathbf{y}_k \in \mathbb{R}^{\mu} \quad \forall k \in \mathcal{K} \quad (18)$$

$$\mathbf{z}_k \in \mathbb{Z}^{\lambda} \quad \forall k \in \mathcal{K} \quad (19)$$

In the objective function (14), the term  $f_0(\mathbf{x})$  corresponds to the design cost whereas the term  $f_k(\mathbf{y}_k, \mathbf{z}_k)$  computes the operation cost for each selected day  $k$  in the set  $\mathcal{K} = \{(\phi, d), \phi = 1 \dots \Phi, d \in \mathcal{D}_{\phi}\}$ . Constraints (15) correspond to the design constraints. Constraints (16) represent in a concise manner all the operations constraints relative to day  $k \in \mathcal{K}$ . Constraints (17)-(19) give the definition domain of each variable vector. Problem (14)-(19) will be referred to as the Complete Model (CM) in what follows.

Note how all design variables are defined as integer variables in (17). This restriction is added to the problem as it is a necessary condition for the use of the hierarchical decomposition algorithm proposed by Yokoyama et al. (2015).

This hierarchical decomposition algorithm uses as a starting point a relaxation of (CM) in which the design variables  $\mathbf{x}$  are kept integer or binary whereas the binary or integer operation variables  $\mathbf{z}$  are relaxed. This gives the following semi-relaxed or upper level problem denoted by (SRM).

$$\min Z_{SRM} = f_0(\mathbf{x}) + \sum_{k \in \mathcal{K}} f_k(\mathbf{y}_k, \mathbf{z}_k) \quad (20)$$

$$h(\mathbf{x}) \leq 0 \quad (21)$$

$$g_k(\mathbf{x}, \mathbf{y}_k, \mathbf{z}_k) \leq 0 \quad \forall k \in \mathcal{K} \quad (22)$$

$$\mathbf{x} \in \mathbb{Z}^\nu \quad (23)$$

$$\mathbf{y}_k \in \mathbb{R}^\mu \quad \forall k \in \mathcal{K} \quad (24)$$

$$\mathbf{z}_k \in \mathbb{R}^\lambda \quad \forall k \in \mathcal{K} \quad (25)$$

Problem (SRM) thus involves the same number of variables and constraints as the initial problem (14)-(19). However, the number of binary and integer variables is drastically reduced, which should ease its resolution.

Furthermore, the hierarchical decomposition algorithm relies on the key observation that in Problem (CM), when the design of the system is determined, the problem can be decomposed into a set of small independent operation sub-problems. Let Problem  $OM_k(\mathbf{x}^\sharp)$  be the Operation Model relative to the optimization of the schedule of day  $k \in \mathcal{K}$ , given a fixed design of the system described by vector  $\mathbf{x}^\sharp$ . It is formulated as:

$$\min Z_k(\mathbf{x}^\sharp) = f_k(\mathbf{y}_k, \mathbf{z}_k) \quad (26)$$

$$g_k(\mathbf{x}^\sharp, \mathbf{y}_k, \mathbf{z}_k) \leq 0 \quad (27)$$

$$\mathbf{y}_k \in \mathbb{R}^\mu \quad (28)$$

$$\mathbf{z}_k \in \mathbb{Z}^\lambda \quad (29)$$

## 4.2 Decomposition Algorithm

The decomposition algorithm proposed by Yokoyama et al. (2015) exploits the hierarchical structure described above. Thus, at the upper level, a relaxed version of the initial problem, i.e. problem SRM, is solved by a Branch & Cut algorithm. Each time a potential incumbent solution  $(\mathbf{x}^\sharp, \tilde{\mathbf{y}}, \tilde{\mathbf{z}})$  is found during this tree search, the corresponding values of the design variables  $\mathbf{x}^\sharp$  are used as input data to solve a series of independent scheduling sub-problems, namely problems  $OM_k(\mathbf{x}^\sharp), k \in \mathcal{K}$ . This gives an accurate estimation of the feasibility and value of the potential design solution  $\mathbf{x}^\sharp$  at the operation level. If  $\mathbf{x}^\sharp$  is found to be feasible and less expensive than the current incumbent solution, it is accepted as the new incumbent solution. Otherwise, it is rejected. When all the branches are searched in the upper level Branch & Bound search tree, the current incumbent solution gives the optimal solution of the original problem. This hierarchical decomposition approach, provided it converges within the allotted computation time, thus guarantees the optimality of the found solution.

More precisely, the algorithm comprises the following main steps. See also Figure 2 for a flow chart of the decomposition algorithm.

*Step 1.* A Branch & Bound search tree is carried out within the feasible space of problem SRM: see ① on the flow chart. The branching is done on the design variables  $\mathbf{x}$  until there is no open node left, in which case we end the calculation, or an integer feasible solution of SRM, denoted by  $(\mathbf{x}^\sharp, \tilde{\mathbf{y}}, \tilde{\mathbf{z}})$ , is obtained, in which case we go to Step 2. The value  $\tilde{Z}(\mathbf{x}^\sharp) = f_0(\mathbf{x}^\sharp) + \sum_{k \in \mathcal{K}} f_k(\tilde{\mathbf{y}}_k, \tilde{\mathbf{z}}_k)$  provides a lower bound of the actual cost of the design solution  $\mathbf{x}^\sharp$ .

*Step 2.* Before accepting  $\mathbf{x}^\sharp$  as a new incumbent solution for the upper level problem, we check its feasibility and compute its actual cost  $Z(\mathbf{x}^\sharp)$ .

- We first initialize the value of  $Z(\mathbf{x}^\sharp)$  as  $Z(\mathbf{x}^\sharp) \leftarrow \tilde{Z}(\mathbf{x}^\sharp)$ .

Then, for each  $k \in \mathcal{K}$ :

- We solve Sub-problem  $OM_k(\mathbf{x}^\sharp)$  using a standard Branch & Cut algorithm: see ② on the flow chart.

- If  $OM_k(\mathbf{x}^\sharp)$  is unfeasible,  $\mathbf{x}^\sharp$  cannot be feasible for Problem (CM). We stop and go to Step 4.

- Otherwise, we record the optimal integer solution of  $OM_k(\mathbf{x}^\sharp)$ ,  $(\mathbf{y}_k, \mathbf{z}_k)$ , and its optimal cost  $f_k(\mathbf{y}_k, \mathbf{z}_k)$ .

- We update the current estimation of the actual cost of the design solution  $\mathbf{x}^\sharp$  by computing  $Z(\mathbf{x}^\sharp) \leftarrow Z(\mathbf{x}^\sharp) + f_k(\mathbf{y}_k, \mathbf{z}_k) - f_k(\tilde{\mathbf{y}}_k, \tilde{\mathbf{z}}_k)$ .

- If  $Z(\mathbf{x}^\sharp)$  is larger than the incumbent value,  $\mathbf{x}^\sharp$  cannot be an optimal solution of Problem (CM). We stop and go to Step 4: see ③ on the flow chart.

- If all days in  $\mathcal{K}$  have been considered, we go to Step 3. Otherwise, we go on with the next day in  $\mathcal{K}$ .

*Step 3.* We replace the incumbent solution by  $(\mathbf{x}^\sharp, \mathbf{y}, \mathbf{z})$  and the incumbent value by  $Z(\mathbf{x}^\sharp)$  and go to Step 4: see ④ on the flow chart.

*Step 4.* We reject the current node in Problem SRM to prevent the solver from taking the semi-relaxed objective value of the design solution  $\mathbf{x}^\sharp$ ,  $\tilde{Z}(\mathbf{x}^\sharp)$ , as a valid upper bound to be used for the rest of the Branch & Bound search at the upper level. This allows us to guarantee that the cutoff value taken into account to close nodes in the branching process is the actual cost  $Z(\mathbf{x}^\sharp)$  of the current incumbent design solution  $\mathbf{x}^\sharp$ , see Yokoyama et al. (2015). Then go back to Step 1: see ⑤ on the flow chart.

Finally, we noted in our preliminary experiments, that while running the hierarchical algorithm described above, we often had to solve multiple times the same operations problem  $OM_k(\cdot)$ . Namely, two different design solutions  $\mathbf{x}^1$  and  $\mathbf{x}^2$  may e.g. be similar for the first phases and differ only for the last phases. It may also happen that two different design solutions  $\mathbf{x}^1$  and  $\mathbf{x}^2$  differ with respect to the decisions relative to the first phases of the horizon but give the



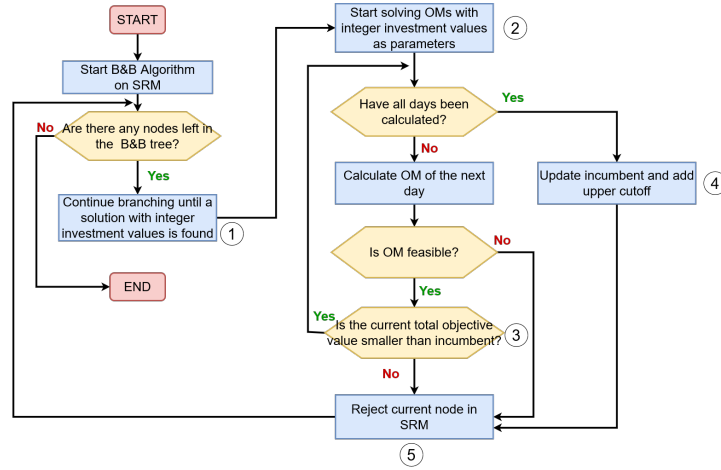

Figure 2: Flow chart of hierarchical decomposition algorithm.

same system infrastructure for the last phases. In both cases, operations problems  $OM_k(\mathbf{x}^1)$  and  $OM_k(\mathbf{x}^2)$  will be equivalent for all the selected days  $k$  corresponding to the phases in which  $\mathbf{x}^1$  and  $\mathbf{x}^2$  provide the same system infrastructure.

In order to avoid this useless computational effort, we thus modify the implementation of the hierarchical decomposition algorithm. When the operation cost of a newly encountered system infrastructure needs to be evaluated for a given phase, the operation sub-problems relative to this phase are solved and the corresponding optimal operation cost  $\sum_{k \text{ st. } d \in \mathcal{D}_\phi} f_k(\mathbf{y}_k, \mathbf{z}_k)$  is recorded in memory. Then, over the course of the algorithm, each time the operation cost of a design solution corresponding to the same system infrastructure in the same phase needs to be evaluated, we simply use the recorded value without recomputing it from scratch.

## 5 PRELIMINARY NUMERICAL RESULTS

In order to assess the performance of the proposed solution approach, we consider a real-life case study corresponding to a DCS under construction in China.

The expected lifetime of the cooling system is 30 years. The total annual cooling demand is anticipated to increase in the first three years and stay stable afterwards. We thus consider  $\Phi = 3$  investment phases. Phases 1 and 2 correspond to the first two years whereas Phase 3 corresponds to the last 28 years. To show the increase in demand, we compare in Table 1 the total yearly demand, which is the sum of demand of one year, and the maximum hourly demand for each phase. New chillers and storage ca-

capacity should be installed at the beginning of the first three years to guarantee that the cooling supply will meet the increasing demand. The hourly cooling demand value is predicted by combining historical data on the cooling consumption in the area and forecasts on the future number of clients which will connect to the DCS.

There are  $L_{STDC} = 3$  types of standard chillers and  $L_{ICEC} = 2$  types of ice chillers available. Their maximum output capacity  $P_{p,l,c}^{max}$  and installation cost  $FC_{\phi,m}$  (in millions of CNY) are shown in Table 3. Note that chillers of type  $(STDC, 1)$  and  $(STDC, 2)$  have the same maximum output capacity  $P_{p,l,COLD}^{max}$  but chillers of type  $(STDC, 2)$  are less efficient and less expensive than the ones of type  $(STDC, 1)$ . For each type of chiller and each corresponding commodity, the minimum output power  $P_{p,l,c}^{min}$  is equal to  $0.10P_{p,l,c}^{max}$ . Figures 3 and 4 display the performance curves of the available standard and ice chillers at an ambient temperature of  $30^\circ C$ . We use  $B_{t,m,c} = 4$  breakpoints to build the piecewise linear approximation of the performance curve of the chillers of type  $m$  producing commodity  $c$  at time period  $t$ . The coordinates are determined by solving a small non-linear optimization problem thanks to a heuristic method belonging to the numpy package in Python. Finally, for each type of chiller  $m$ , the maximum number of chillers that can be installed,  $SD_m^{max}$  is set to 10.

The unit cost of installing ice storage capacity  $LC_\phi$  is 222.16CNY per kWh and the unit subscription cost for the maximum instantaneous power allowed,  $SC_\phi$ , is 276CNY per kW. Since the installed storage capacity and the subscribed contract power are discretized, a unit of storage capacity is 6000kWh and a unit of contract power is 3000kW. The installed storage capacity should be lower than  $StoC^{max} = 200GWh$  and the contract power should be no more than 30GW.

The discount rate  $\alpha_\phi$  is 8%.

The electricity price features a daily seasonality but no weekly nor yearly variations. Figure 5 shows the unit price of electricity as a function of the hour of the day. As the electricity price does not change with the day in the week or the season, the typical days and extreme days are selected so as to represent as best as possible the variations in the cooling power demand. For each phase, 30 typical days are selected using the approach proposed by Zatti et al. (2019) and 4 extreme days are identified: the day with the highest hourly demand, the one with the highest total demand, the one with the lowest non-zero hourly demand and the one with the lowest non-zero total demand. Therefore, there are a total of  $34 \times 3 = 102$  operation sub-problems.

This results in the formulation of a large-size MILP. The model involves 64381 variables, among which 22053 are integer and 600 are binary, as well as 101422 constraints. This MILP is solved using the hierarchical decomposition algorithm presented in Section 4. This algorithm is implemented in Python using the mathematical programming solver CPLEX12.8. All the problems are solved using a machine with a Intel Xeon 2.90GHz processor and 16GB RAM.

Table 4 describes the optimal solution in terms of the number of chillers and the storage capacity built in each phase, together with the contract power. Figure 6 shows the operation of chillers and storage in one of the typical days. The periods in which the ice production of (ICEC,2) seems to take negative value correspond to periods in which ice is produced and stored in the tank.

Furthermore, we carried out additional experiments in order to get a preliminary assessment of the computational efficiency of the hierarchical decomposition algorithm and to evaluate the impact of the selection of representative days on the infrastructure design. We thus created 4 additional instances based on our case study by varying the number of selected days per phase from 6 to 34. The corresponding results are provided in Table 2. The first line in the table indicates the number of selected days for each phase. Lines 2 to 5 provide indications on the size of the MILP to be solved: we note that the number of variables and constraints in the problem increases linearly with the number of selected days. Lines 6 to 9 correspond to the results obtained while directly solving Problem (CM) with CPLEX12.8 whereas Lines 10 to 13 correspond to the results obtained with the hierarchical decomposition algorithm. For each algorithm, we report the computation time (which was limited to a maximum of 2 hours), the total and design cost of the best solution found within the available time

Table 1: Phases and Demand.

Phase	1	2	3
Length (yr)	1	1	28
Total Yearly Demand (GWh)	54.7	250.0	276.8
Max Hourly Demand (MWh)	13.6	62.2	93.8

limit and the remaining gap (i.e. the relative difference between the values of the best solution and the best lower found after 2 hours of calculation).

These results first show that the hierarchical decomposition algorithm is significantly more efficient than the standard Branch & Cut algorithm embedded in CPLEX12.8. Namely, with this algorithm, we were able to solve to optimality the 5 considered instances, and this with a computation time divided by a factor of at least 2.25.

Moreover, results from Table 2 also show that the system infrastructure found by solving the MILP depends on the number of selected days. This can be seen among others by the fact that the investment cost varies with the number of selected days, which indicates that the structure of the system and the deployment plan vary with this number. We note however that, when using the hierarchical decomposition approach, both the total cost and the investment cost become stable when more than 26 selected days are considered for each phase. Additional computational experiments are needed to determine the exact value of the minimum number of selected days per phase above which the system design does not change any more.

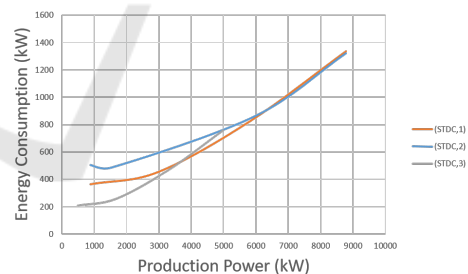

Figure 3: Performance curves of STDC at 30°C.

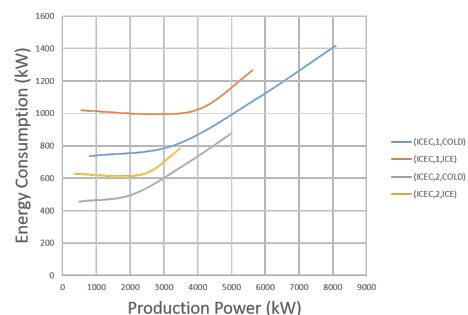

Figure 4: Performance curves of ICEC at 30°C.

Table 2: Comparison between complete model and hierarchical decomposition.

Instance	Number of Days	6	10	18	26	34
Size	Number of Variables	11461	19021	34141	49216	64381
	Number of Integer Variables	3909	6501	11685	16869	22053
	Number of Binary Variables	180	240	360	480	600
	Number of Constraints	17938	29854	53710	77566	101422
CPLEX	Computation time	1726s	>7200s	>7200s	>7200s	>7200s
	Objective Value	$5.50 \times 10^8$	$5.70 \times 10^8$	$5.75 \times 10^8$	$5.75 \times 10^8$	$5.75 \times 10^8$
	Investment Cost	$2.45 \times 10^8$	$2.35 \times 10^8$	$2.36 \times 10^8$	$2.36 \times 10^8$	$2.37 \times 10^8$
	Relative Gap	0.00%	0.02%	0.15%	0.34%	0.42%
Hier. Dec.	Computation time	220s	922s	942s	1435s	1831s
	Objective Value	$5.50 \times 10^8$	$5.70 \times 10^8$	$5.74 \times 10^8$	$5.75 \times 10^8$	$5.75 \times 10^8$
	Investment Cost	$2.45 \times 10^8$	$2.35 \times 10^8$	$2.35 \times 10^8$	$2.35 \times 10^8$	$2.35 \times 10^8$
	Relative Gap	0.00%	0.00%	0.00%	0.00%	0.00%

Table 3: Available chillers.

Type	$P_{p,l,COLD}^{max}$	$P_{p,l,ICE}^{max}$	$FC_m$
(STDC,1)	8791	-	13
(STDC,2)	8791	-	12
(STDC,3)	5000	-	7.7
(ICEC,1)	8087	5626	13
(ICEC,2)	5000	3478	8.3

Table 4: Optimal system design and phasing obtained with 30 typical days and 4 extreme days at the operation level.

Phase	1	2	3
(STDC,1)	0	0	0
(STDC,2)	1	5	3
(STDC,3)	0	1	0
(ICEC,1)	0	0	0
(ICEC,2)	1	0	0
Storage Capacity (MWh)	24	0	0
Contract Power (MW)	3	9	15

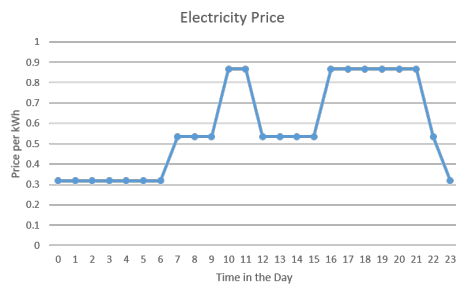

Figure 5: Electricity Price of a Day.

## 6 CONCLUSION

We presented a modeling and solving approach for the optimal design of a district cooling system involving intra-day energy storage over a multi-phase horizon. The modeling approach relies on a clustering algorithm to identify a subset of typical days and on a

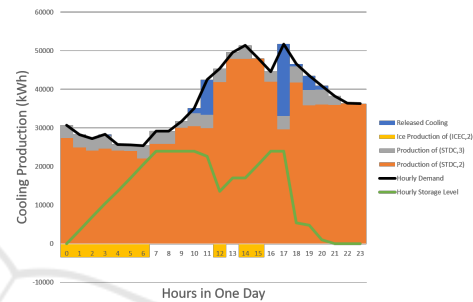

Figure 6: Operation Result of a Typical Day in Phase 3.

piecewise linear approximation of the chillers' performance curves. It results in the formulation of a large-size mixed-integer linear program. An improved hierarchical decomposition method is then implemented to optimally solve this MILP. This decomposition method exploits the hierarchy between upper-level infrastructure design decision and lower-level operation scheduling decisions. Our preliminary computational results carried out on a real-life case study located in China show that the proposed hierarchical decomposition algorithm significantly outperforms a mathematical programming solver at providing optimal solutions of the MILP. Moreover, our results also show that, provided a minimum number of typical days are taken into account to estimate the operation costs, the final system infrastructure and the deployment phasing do not change with the subset of selected typical days, which is an important point to gain the trust of the decision makers.

There are several possible directions for future research suggested by the present work. First, additional computational experiments are needed to evaluate the impact of the use of a limited number of representative days and of the piecewise linear approximation of the chillers' performance curves on the solution provided by the proposed approach. Second, on a longer term perspective, it would be interesting to extend the proposed approach to consider non-convex

performance curves for the chillers and to study more general local energy systems, in particular systems simultaneously providing a district with several sources of energy (electricity, heat, cold, ...).

## REFERENCES

- EMSD (2020). Benefits of dcs. <http://aiweb.techfak.uni-bielefeld.de/content/bworld-robot-control-software/>. [September 9, 2020].
- Iyer, R. and Grossmann, I. E. (1998). Synthesis and operational planning of utility systems for multiperiod operation. *Computers & Chemical Engineering*, 22(7-8):979–993.
- Weber, C., Maréchal, F., and Favrat, D. (2007). Design and optimization of district energy systems. In *Computer aided chemical engineering*, volume 24, pages 1127–1132. Elsevier.
- Yokoyama, R., Shinano, Y., Taniguchi, S., Ohkura, M., and Wakui, T. (2015). Optimization of energy supply systems by MILP branch and bound method in consideration of hierarchical relationship between design and operation. *Energy conversion and management*, 92:92–104.
- Zatti, M., Gabba, M., Freschini, M., Rossi, M., Gambarotta, A., Morini, M., and Martelli, E. (2019). k-milp: A novel clustering approach to select typical and extreme days for multi-energy systems design optimization. *Energy*, 181:1051–1063.

## APPENDIX

### Convex Performance Curves

When the performance curves of the chillers are convex, we have the following property.

**Lemma 1.** *For a set of identical chillers producing the same commodity, the optimal load allocation consists in equally distributing the total output power between the chillers.*

*Proof.* The proof is done by contradiction. Suppose we have two identical chillers, producing a total cooling power of  $P$  with chiller 1 producing  $P^1$  and chiller 2 producing  $P^2 > P^1$ . Let  $\pi : P \mapsto Q = \pi(P)$  be the convex performance curve of these two chillers. The total amount of electricity consumed by the two chillers producing  $P$  is  $Q = \pi(P^1) + \pi(P^2)$ .

We show that this load allocation is not optimal, i.e. that it is possible to reduce the total amount of consumed electricity. Namely, let  $\delta P$  be a small variation in the output. By decreasing the output of chiller

2 by  $\delta P$ , we can obtain a decrease in the electricity consumed by this chiller of  $\pi'(P^2)\delta P$ , where  $\pi'$  is the derivative function of  $\pi$ . In order to still be able to provide a total output of  $P$ , we increase the output of chiller 1 by  $\delta P$ , which leads to an increase in its electricity consumption of  $\pi'(P^1)\delta P$ .

By convexity of function  $f$ ,  $\pi'(P^1) < \pi'(P^2)$ . Hence the total amount of electricity consumed with the load allocation  $(P^1 + \delta P, P^2 - \delta P)$  is smaller than the one consumed with the load allocation  $(P^1, P^2)$ . The result follows.  $\square$

Let us now focus on the case in which the performance curve  $\pi$  is convex and piecewise linear. When multiple identical chillers are simultaneously producing the same commodity, the relation providing the total amount of consumed electricity as a function of the total amount of output power can be plotted as an aggregate performance curve. We have the following property:

**Lemma 2.** *Let  $\pi$  be the piecewise linear and convex performance curve of a given type of chiller.  $\pi$  involves  $B$  breakpoints. Let  $(a_b, o_b)$  be the abscissa and ordinate of breakpoint  $b$ .*

*The aggregate performance curve  $\Pi^S$  of  $S$  identical chillers of this type is also piecewise linear and convex. It involves  $B$  breakpoints whose coordinates are given by  $(Sa_b, So_b)$ .*

*Proof.* Let us consider the case where the total output of the  $S$  chillers is  $P \in [SP^{min}, SP^{max}]$  where  $[P^{min}, P^{max}]$  is the production range of a single chiller.

By Lemma 1, the optimal load allocation consists in requiring each chiller  $\gamma = 1 \dots S$  to produce the same output  $P^\gamma = \frac{P}{S}$ . Let  $b$  be the index of the breakpoint of function  $f$  such that  $P^\gamma \in [a_b, a_{b+1}]$ . The energy consumed by each chiller  $\gamma$  is thus given by:  $Q^\gamma = s_b P^\gamma + c_b$  where  $s_b$  and  $c_b$  are the slope and constant value of the  $b^{th}$  line segment of  $\pi$ . The total energy consumed by the  $S$  chillers is thus equal to  $Q = s_b P + c_b S$ . This equality holds for any value of  $P$  such that  $\frac{P}{S} \in [a_b, a_{b+1}]$ , i.e. any value of  $P \in [Sa_b, Sa_{b+1}]$ . This means that  $\Pi^S$  is linear over the segment  $[Sa_b, Sa_{b+1}]$ , with a slope equal to  $s_b$  and a constant value of  $c_b S$ .

By generalizing this result to all possible values of the total output  $P$ , we have that  $\Pi^S$  is a piecewise linear function involving  $B$  breakpoints of coordinates  $(Sa_b, So_b)$ . Moreover the slope of  $\Pi^S$  on its  $b^{th}$  segment is  $s_b$ . As  $\pi$  is convex, we have  $s_b \leq s_{b+1}, b = 1 \dots B$ .  $\Pi^S$  is thus convex.  $\square$