

Numerical Study of Bilge Keel Length Variations of Floating Breakwater to Optimize Transmission Coefficient

Haryo Dwito Armono¹, Ketut Suastika², Asfarur Ridlwan¹ and Tito Biaperi¹

¹*Department of Ocean Engineering, Institut Teknologi Sepuluh Nopember, Sukolilo, Surabaya, Indonesia*

²*Department of Naval Architecture, Institut Teknologi Sepuluh Nopember, Sukolilo, Surabaya, Indonesia*

Keywords: Floating Breakwater, Bilge Keel, Wings Plate, Computational Fluid Dynamics, Transmission.

Abstract: Waves and winds that move dynamically often cause damage on the coast so a protective beach building is needed. Breakwater is a coastal protection structure to destroy the incoming wave energy before reaching the coast. One type of breakwater is floating breakwater, this structure has an advantage compared to the fixed breakwater. Research on floating breakwater has been developed with the main goal of being the most efficient structure and can absorb waves well. In this research, floating breakwater simulation modeling with variations in bilge keel length was conducted. Validation is done by comparing the results of (GH Dong, 2008) with numerical results of the breakwater pontoon type. There are four variations of bilge keel length, namely 0 m, 0.6 m, 0.9 m, and 1.2 m. So, four variations can be concluded that the longer the bilge keel, the better absorb the waves.

1 INTRODUCTION

Coastal areas need to be considered for safety against erosion and wave surges. One of the structures to protect the coast from waves is a breakwater. There are two types of breakwater, bottom-founded breakwater, and floating breakwater. Floating breakwater has the advantage of bottom-founded breakwater: (1) The time of construction is shorter because it has been done in fabrication, (2) floating breakwater can be easily moved, reassembled with different layouts, and can be moved to different locations, (3) floating breakwater is suitable for muddy soil, (4) floating breakwater is more environmentally friendly because it does not cause pollution and sedimentation.

Floating breakwater (FB) research began around one century ago, many studies and model tests were carried out to develop floating breakwater. As technology develops, research on floating breakwater is rapidly increasing. There have been many studies exploring floating breakwater where exploration will continue to be developed to obtain the most optimal results.

Experimentally and numerically of floating breakwaters have been studied. According to G.H Dong (2008), floating breakwater can be used

effectively in coastal areas with relatively mild wave conditions. His experiment was to find a simple and relatively inexpensive type, by studying 3 types of structures including the shape of a single box, double box, and board net. (Wang and Sun, 2010) conducted a study of porous breakwater where the structure was fabricated with large numbers of diamond-shapes blocks arranged to reduce transmitted wave height and the mooring force. (Drimer et al., 1992) conducted a study of the simplification of a floating breakwater design where width and wavelength are the greater than the gap between the breakwater position and sea bed. (William and Abul-Azm, 1997) conducted a study of the hydrodynamic characteristics of a dual pontoon floating breakwater consisting of a rectangular floating cylinder connected by a rigid deck. (Liang et al., 2004) conducted research on the reflection and wave transmission of floating breakwater spar bouys as a well mooring forces.

This paper presents numerical simulation to analysis transmission coefficients using computational fluid dynamics (CFD) method. The basic geometry is pontoon floating breakwater that modified in several length variations of bilge keel on the bottom of structure. Data parameters and numerical model verifications based on the result of experiments that conducted by (G.H. Dong., 2008).

2 NUMERICAL SIMULATIONS

2.1 Dimension of Floating Breakwater

Floating breakwater dimension is obtained from international journal data entitled “Experiments on wave transmission coefficients of floating breakwaters” by G.H Dong (2008). See figure 1 and figure 2 for cross section of the prototype of floating breakwater by GH Dong. The data will be used to compare the G.H Dong experimental test with a numerical test. The data that will be used in numerical test modelling are as follows, see table 1.

2.2 Data Parameters

Research conducted by (G H Dong, 2008) uses environmental data (wave height and wave period data). The test uses a model scale, so the environmental data used data that has been scaled too. The data are scaled by assuming Froude scaling to be valid. For detail, see table 2.

Table 1: Pontoon Dimensions.

No	Dimension	Prototype [m]	Scale	Model [m]
1	Length (L)	20	1:40	0.50
2	Width (B)	6	1:40	0.15
3	Height (H)	4.8	1:40	0.12

Table 2: The Wave Parameter Data (Froude Scaling).

No.	Dimension	Prototype	Scale	Model
1.	Wave Height	2.5 m	1:40	0.0625m
2	Wave Period	6 s	1:√40	0.949 s
		7 s	1:√40	1.107 s
		8 s	1:√40	1.265 s
		9 s	1:√40	1.423 s
		10 s	1:√40	1.581 s

2.3 The Wave Flume

Wave flume that is modeled is in the State Key Laboratory of Coastal and Offshore Engineering, Dalian University of Technology, China. The flume is 20 m long, 3 m wide, 1 m high, and 0.5 m water depth. The flume is filled water with density of 1000 kg/m³. The flume is equipped with a hydraulically driven, piston-type irregular wave generator at one end and a wave absorber at the other. The floating breakwater model is located at 20 meters from the wave maker. The waves come from the left toward the right across the structure. The number of wave probes used is two, probe 1 is located 3 meters in front of the structure and probe 2 is located at 3 meters behind the structure. See, Fig. 3 for illustration.

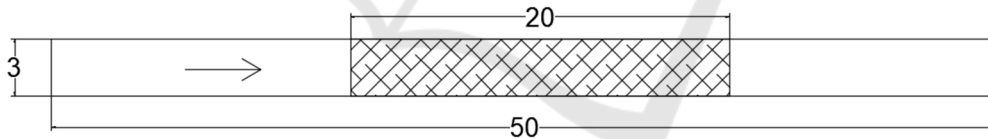

Figure 1: Basic Cross-section Pontoon FB (Top View).

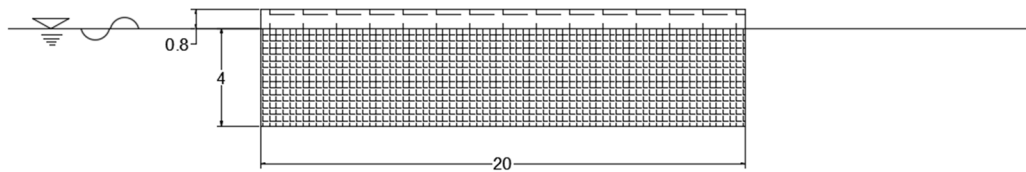

Figure 2: Basic Cross-section Pontoon FB (Side View).

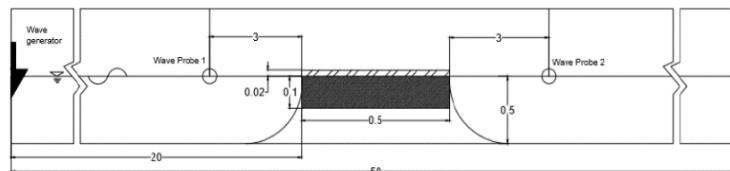

Figure 3: Sketch of Wave Flume (Side View).

2.4 Developed Floating Breakwater

Developed floating breakwater is intended to determine shapes of floating breakwater which is effective in reducing wave energy. Developed shape of floating breakwater refers to the single-box floating breakwater by GH Dong. Therefore, this research will be changed variations of bilge keel length. The developed floating breakwater can be seen on figure 4.

2.5 Wave Measurements and Analysis

The objective of this study was to obtain the transmission coefficient (C_T), the ratio of transmitted wave height (H_T) to incident wave height (H_i). See equation 1 below:

$$C_T = H_T / H_i \quad (1)$$

Measurement of transmitted and incident wave heights were represented by surface elevation using wave gauges.

2.6 Mooring System

The structure is connected to the sea bed by mooring chains. There are six mooring chains on each side of floating breakwater. Each mooring chain is 0.1 m in diameter, 60 m in length, and 230 kg/m in unit mass.

2.7 Boundary Conditions

The purpose of boundary conditions is to determine model conditions that represented experiment conditions. See figure 5. Boundary conditions used in the model are as follow:

- (1) Free surface (Wave): A wave boundary condition was defined at left (X Min). A surface wave entered the computational domain and propagated in the direction normal to the boundary. The wave was set 2nd stokes as wave generator represent the physical wave conditions at the boundary.

- (2) Outflow: The outflow boundary condition was defined at right (X Max). It allowed users to numerically investigate the effects of wave interactions with structures. The capability permitted a reduction in the extent of the computing mesh needed for accurate computations. A wave-absorbing layer used to reduce reflection of periodic wave at an open boundary.
- (3) Symmetry: The symmetry condition was defined at front (Y Min), behind (Y Max), below (Z Min), and up (Z Max). No-slip conditions were imposed using the wall shear-stress options described in the Prandtl Mixing Length model. A symmetry condition can be specified as free-slip conditions that have a non-zero wall shear-stress.

2.8 Meshing

Mesh block is used to determine the area that modelled. The smaller mesh will be more detailed, but the output files will be larger and simulations run longer. Floating breakwater modelling used two mesh block, (1) Block A with a meshing size of 0.06 m at total length (X-axis) is 20 m, total width (Y-axis) is 3 m, and total height (Z-axis) is 1 m, (2) Block B with a meshing size of 0.01 at length (X-axis) is 19.95-20.19, width (Y-axis) is 1.2-1.8, and height (Z-axis) is 0.4-0.6. See figure 6 for the illustration.

3 RESULTS AND DISCUSSION

3.1 Validation

Validation is done by comparing the experiment result with the modelling result. The comparison uses a transmission coefficient which is illustrated in one graph (H/L Vs K_t). Validated if the modeling results show the similarity of trend curve with experimental results. If not, redesign the geometry model and do the modeling again until the results really match.

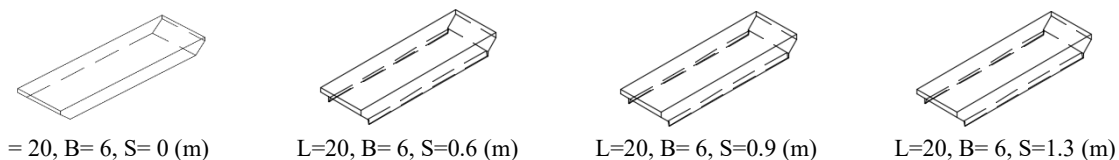

Figure 4: Developed of Floating Breakwater (S = Bilge Keel Length) in meter.

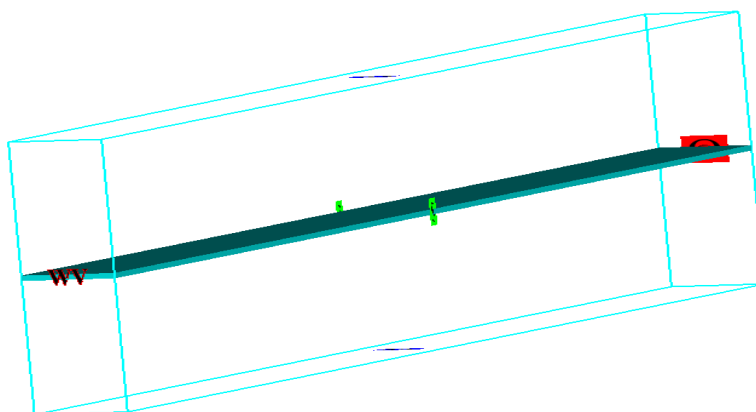

Figure 5: Boundary Conditions Model.

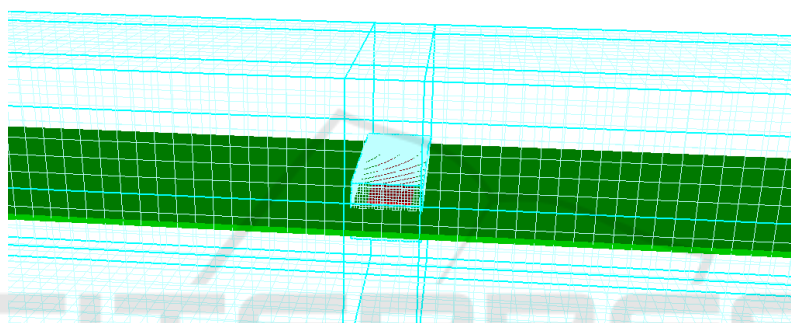

Figure 6: Mesh-size Model.

Here, the results of modeling validation with the experiment are shown on tabel 3. More detail see figure 7.

Table 3: The Validation of Transmission Coefficient.

H	T	H/L	K _T		Error
			Numeric	Experiment	
0.949	0.0452	0.325	0.325	0.356	7%
1.107	0.0345	0.661	0.661	0.654	2%
0.0625	1.265	0.0282	0.908	0.844	8%
1.425	0.0238	0.960	0.960	0.873	10%
1.581	0.0206	0.891	0.891	0.815	10%

The graph on figure 7 explain that the transmission coefficient in numerical modeling and experiment test has almost the same similarity and valid based on Mean Absolute Percentage Error (MAPE) theory. However, there are still difference in value of transmission coefficient which may be caused by differences in recording wave gauges or meshing size.

3.2 Transmission Coefficient Result

3.2.1 Model 1 (Without Bilge Keel)

Data from modeling of floating breakwater in Model 1 (without bilge keel) were obtained from recording of waves elevation on wave gauges in the form of time series data. The data is then processed using statistics Wave Analysis (WAVAN). The following is transmission coefficient result in Model 1, see table 4.

3.2.2 Model 2 (0.6 m Length of Bilge Keel)

Data from modeling of floating breakwater in Model 2 (0.6 m length of bilge keel) were obtained from recording of waves elevation on wave gauges in the from of time series data. The data is then processed using statistics Wave Analysis (WAVAN). The following is transmission coefficient result in Model 2, see tabel 5.

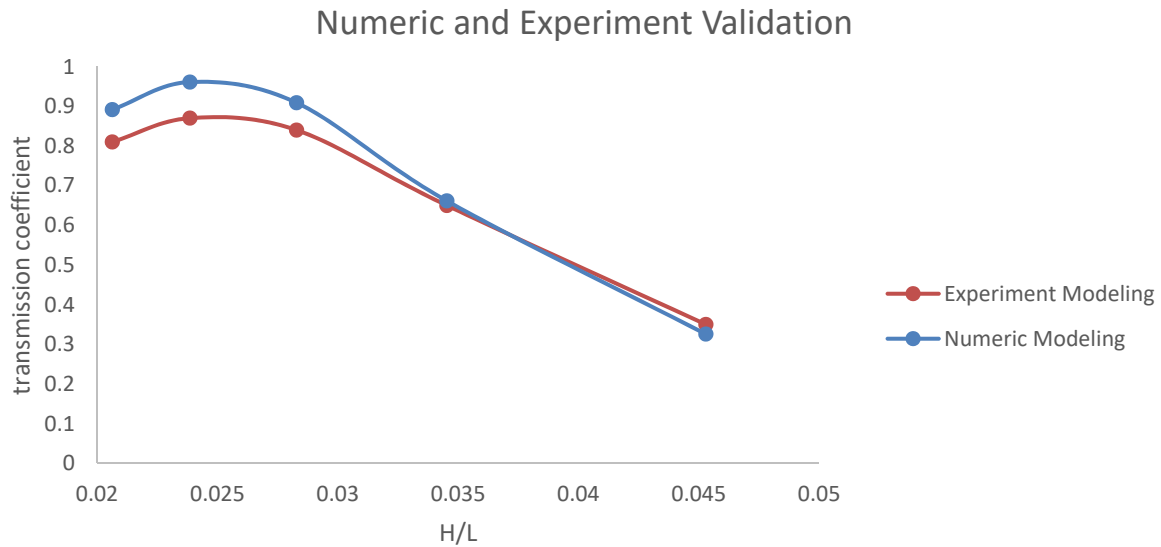

Figure 7: Validation graphic (K_T Vs H/L).

3.2.3 Model 3 (0.9 m Length of Bilge Keel)

Data from modeling of floating breakwater in Model 3 (0.9 m length of bilge keel) were obtained from recording of waves elevation on wave gauges in the from of time series data. The data is then processed using statistics Wave Analysis (WAVAN). The following is transmission coefficient result in Model 3, see tabel 6.

3.2.4 Model 4 (1.3 m Length of Bilge Keel)

Data from modeling of floating breakwater in Model 4 (1.3 m length of bilge keel) were obtained from recording of waves elevation on wave gauges in the from of time series data. The data is then processed using statistics Wave Analysis (WAVAN). The following is transmission coefficient result in Model 4, see tabel 7.

3.3 Comparison Model Result

In order to know the results that are easily understood, numerical modellings of Model 1 up to Model 4 are compared in one graph as shown in figure 8. Figure 8 shows the correlation of transmission coefficient (K_T) with wave steepness (H/gT^2) at depth of 0.5 meters and variations in wave height (H) and wave period (T). Transmission coefficient in model 1 ranges from 0.233-0.390, model 2 ranges between 0.221-0.377, model 3 ranges between 0.210-0.370, and model 4 ranges between 0.205-0.365. The higher the wave height the smaller the wave period is the steeper the wave steepness. Figure 8 shows that each model has

a transmission coefficient that continues to decrease with increasing wave steepness.

Table 4: Graphic of K_T Vs H/gT^2 on Model 1.

No	H_i	T_i	H/gT^2	K_T
1	0.0240	0.800	0.004	0.390
2	0.0380	0.684	0.009	0.298
3	0.0550	0.658	0.012	0.281
4	0.0550	0.575	0.016	0.233

Table 5: Graphic of K_T Vs H/gT^2 on Model 2.

No	H_i	T_i	H/gT^2	K_T
1	0.0240	0.800	0.004	0.377
2	0.0380	0.684	0.009	0.287
3	0.0550	0.658	0.012	0.270
4	0.0550	0.575	0.016	0.221

Table 6: Graphic of K_T Vs H/gT^2 on Model 3.

No	H_i	T_i	H/gT^2	K_T
1	0.0240	0.800	0.004	0.370
2	0.0380	0.684	0.009	0.278
3	0.0550	0.658	0.012	0.260
4	0.0550	0.575	0.016	0.210

Table 7: Graphic of K_T Vs H/gT^2 on Model 4.

No	H_i	T_i	H/gT^2	K_T
1	0.0240	0.800	0.004	0.365
2	0.0380	0.684	0.009	0.265
3	0.0550	0.658	0.012	0.250
4	0.0550	0.575	0.016	0.205

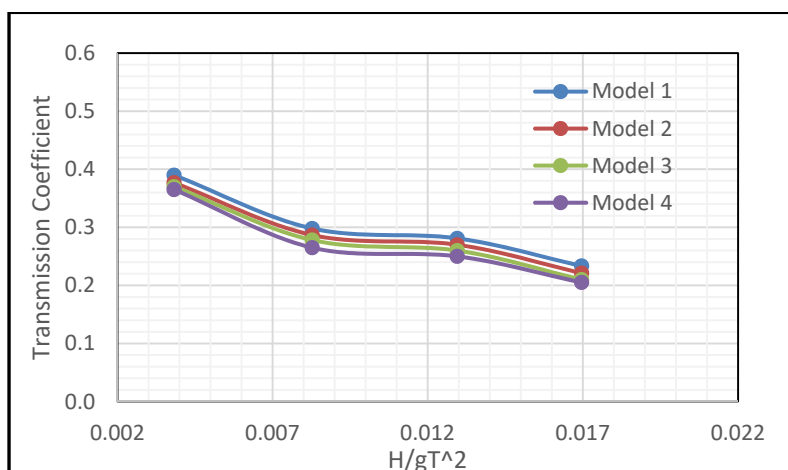

Figure 8: Comparison of Four Models Results (K_T Vs H/gT^2).

4 CONCLUSIONS

In this study, a two-dimensional numerical simulation was analysed for floating breakwater. Previously, the results were validated by experiments that had been carried out by G.H Dong. After that, the development of floating breakwater shapes are analysed by numerical simulation using Computational Fluid Dynamics (CFD) method. There are four development shapes of floating breakwater analysed that are based on the length of bilge keel. The results are that longer the bilge keel, the more efficient the transmission coefficient can reduce wave energy.

ACKNOWLEDGEMENTS

This study was in part of founded Directorate General of Resources for Science Research. The Author would like thanks to the team research and the Directorate General of Resources for Science, Technology and Higher Education; Ministry of Research, Technology and Higher Education, the Republic of Indonesia, which funding this project of research.

REFERENCES

Armono, HD. Supriadi, H., Yuniardo., RK. 2009. "Pemakaian Floaton untuk Pemecah Gelombang Terapung (Floating Breakwater)", Prosiding Seminar Nasional Teori dan Aplikasi Teknologi Kelautan IX, Kampus ITS Surabaya

Armono, HD., Suastika., KS., Sujantoko., Sholihin., Supriadi, H. 2011. "Laporan Akhir Riset Andalan Perguruan Tinggi dan Industri : Rancang Bangun Floating Breakwater High Density Polyethylene untuk Pulau-pulau Kecil di Indonesia", LPPM ITS

Bellingham Marine Industries Inc., 2014, Unifloat Wave Attenuator Systems, [brochure], (www.bellingham-marine.com, diakses pada tanggal 1 September 2018)

Dong, G.H., Zheng, Y.N., Lia, Y.C., Tenga, B., Guanc, C.T., Lin., D.F. 2008. "Experiments on Wave Transmission Coefficients of Floating Breakwaters", *Ocean Engineering* 35 (2008) 931–938.

Drimer, N., Agnon, Y., Stiassnie, M. A simplified analytical model for a floating breakwater in water of finite depth, *Applied Ocean Research* Vol. 14 (1) (1992) 33-41, [https://doi.org/10.1016/0141-1187\(92\)90005-5](https://doi.org/10.1016/0141-1187(92)90005-5).

Fahli Achmad Zulfikar Fazli , Minggu, 20 Nov 2016 15:37 WIB, Indonesia Hanya Punya Lima Pelabuhan Marina, di akses 2 Sep 2018 dari <http://news.metrotvnews.com/peristiwa/MkMynMpk-indonesia-hanya-punya-lima-pelabuhan-marina>,

Floating Breakwaters., di akses 2 September, 2013, dari <http://sfmarinausa.com/floating-breakwaters/>

Floating Breakwaters di akses 2 September, 2013, dari <http://www.freepatentsonline.com>

Floating breakwater in Messolonghi, Greece., di akses 2 September, 2013, dari <http://www.fdn-engineering.nl/floating-breakwater-in-messolonghi>

Fousert M.W. 2006, Floating Breakwater , "A Theoretical Study of a Dynamic Wave Attenuating System", Master Thesis, Delft University of Technology.

Hirt, C.W., and Nichols, B.D., (1981). "Volume of Fluid (VOF) Method for the Dynamics of Free Boundaries", *Journal of Computational Physics* Vol. 39, pp. 201-225.

Kurniawan, R. (2013). Model Numerik Koefisien Transmisi pada Floating Breakwater Trapesium dengan FLOW3D, Tugas Akhir Jurusan Teknik Kelautan FTK ITS.

- Liang, N.K., Huang, J.S., Li, C.F. A study of buoy floating breakwater *Ocean Engineering*, 31 (2004), pp. 43-60.
- Mangor, K. 2004. "Shoreline Management Guidelines". DHI Water and Environment, 294p.
- Pena, E., Ferreras, J., Sanchez-Tembleque, F., 2011."Experimental Study on Wave Transmission Coefficient, Mooring Lines and Module Connector Forces with Different Designs of Floating Breakwaters". *Ocean Engineering* 38 (2011)1150–1160.
- Pusat Penelitian Kelautan ITS, 2015. Road Map Penelitian Pusat Penelitian Kelautan ITS 2015-2019.
- US Army Corps of Engineers., (2000), "Coastal Engineering Manual"
- Wang, H.Y., Sun, Z.C. Experimental study of a porous floating breakwater, *Ocean Engineering* 37 (5–6) (2010), 520-527. <https://doi.org/10.1016/j.oceaneng.2009.12.005>.
- Williams, A.N. , Abul-Azm, A.G. Dual pontoon floating breakwater, *Ocean Engineering* 24 (5), (1997), 465-478, [https://doi.org/10.1016/S0029-8018\(96\)00024-8](https://doi.org/10.1016/S0029-8018(96)00024-8).

