

# Ankle-Knee Prosthesis with Powered Ankle and Energy Transfer

## Development of the CYBERLEGS Alpha-Prototype

Louis Flynn<sup>1</sup>, Joost Geeroms<sup>1</sup>, Rene Jimenez-Fabian<sup>1</sup>, Bram Vanderborgh<sup>1</sup>, Nicola Vitiello<sup>2</sup>  
and Dirk Lefeber<sup>1</sup>

<sup>1</sup>Department of Mechanical Engineering, Vrije Universiteit Brussel, Pleinlaan 2, Brussels, Belgium

<sup>2</sup>The BioRobotics Institute, Scuola Superiore Sant'Anna, viale Rinaldo Piaggio 34, Pisa, Italy

**Keywords:** Prosthesis, Knee, Ankle, Energy Efficiency, Transfemoral, CYBERLEGS, Active, Energy Transfer.

**Abstract:** Active prostheses have recently come onto the market, but are limited to modular forms without connections between the knee and ankle modules. Here we present the simulation, design, and preliminary data of a new knee-ankle prosthesis with an actuated ankle based on a variable stiffness actuator with energy transfer from the knee to the ankle as a part of the CYBERLEGS FP7-ICT project. The CYBERLEGS  $\alpha$ -Prosthesis utilizes a novel active ankle joint architecture and energy transfer mechanism to transfer energy from the knee joint to the ankle. The device is capable of producing a level ground walking gait that closely approximates the joint torques and kinematics of a non-amputee while maintaining compliant joints, which has the potential to decrease impulse losses, and ultimately reduce the end user energy consumption. This first prototype consists of a passive knee and an active ankle, which are energetically coupled to reduce the total power consumption of the device.

## 1 OBJECTIVES

Recent years have seen the commercialization of a number of active prostheses designed to restore the full ankle (Hitt et al., 2007; Au et al., 2008) and knee (Ossur, 2013) joint capability during normal walking, as well as provide some sit to stand and stair climbing operations. In addition to the newest commercial models, there are a number of active ankle (Cherelle et al., 2012; Bellman et al., 2008) and knee modules (Villalpando et al., 2008), as well as combined ankle knee systems (Sup et al., 2008) under development, seeking to improve the functionality and reduce energy consumption of the devices with the goal of extending their capabilities and duration between recharging. These new devices have been spurred by developments in materials, electric motors, batteries, and miniaturized controllers, combined with actuators that are better suited to biomechanical use (Hollander et al., 2006; Au and Herr, 2008; Vanderborgh et al., 2013).

The increased metabolic costs, increased forces, and abnormal gait kinematics associated with using standard passive prostheses are well known (for example (Kaufman et al., 2008)) and make it difficult for weaker users to use passive prostheses, a prob-

lem which may be solved through the use of active prostheses. One of these new active prostheses, the BiOM (iWalk, 2013), has been shown to reduce the metabolic input of the user during level ground walking to the level of a non-amputee (Herr and Grabowski, 2012). Reducing the metabolic costs of walking through the use of an active prosthesis may allow patients in groups who have weakness in the intact limbs or are generally in poor condition, such as dysvascular patients, to use a prosthesis when they cannot use current passive technologies.

Connecting the knee and ankle for coupling kinematics has been used in prostheses for centuries, mainly to provide dorsiflexion during swing phase, aiding ground clearance. Because the knee performs primarily negative work during normal walking, energy that would normally be dissipated by the knee can be used for powering pushoff. Knee-ankle energy transfer mechanisms for powering pushoff have been tested in a number of passive devices, such as (Unal et al., 2010) from the University of Twente, and at the Vrije Universiteit Brussel (Matthys et al., 2012), but have not been used in an active design. These devices are designed to transfer energy that would be dissipated by the knee (13J for an 80kg person), and transfer it to the ankle, which requires around 18J during

pushoff.

Here we present the simulation, design, and preliminary data of a new knee-ankle prosthesis with an actuated ankle based on a variable stiffness actuator with energy transfer from the knee to the ankle as a part of the CYBERLEGS FP7-ICT project.<sup>1</sup> The CYBERLEGS  $\alpha$ -Prosthesis utilizes a novel active ankle joint architecture and energy transfer mechanism to transfer energy from the knee joint to the ankle. The device is capable of producing a level ground walking gait that closely approximates the joint torques and kinematics of a non-amputee while maintaining compliant joints, which has the potential to decrease impulse losses, and ultimately reduce the end user energy consumption. This first prototype consists of a passive knee and an active ankle, which are energetically coupled to reduce the total power consumption of the device.

## 2 METHODS

Although the ultimate goal is to build a combined ankle knee prosthesis, understanding the behavior of each component separately allows a better understanding of the effects of the combined ankle-knee transfer system.

### 2.1 Ankle

During level ground walking, the ankle joint requires a positive joint work of approximately 18J per step for an 80Kg individual walking at 1 stride/second. It is first assumed that this energy will be provided solely through an adaptable-compliance, MACCEPA based actuator.

A variation of a MACCEPA, a variable compliance actuator well suited for biologically inspired robots (Van Ham et al., 2007; Vanderborght et al., 2013), was designed for the ankle joint and the realization of the design can be found in Figure 2. This is a redesigned actuator, solving many of the problems with previous MACCEPA designs, such as removing cable systems and using compact compression springs. The system also is capable of providing 120 Nm torque at the ankle, a requirement to provide

<sup>1</sup>The CYBERnetic LowEr-Limb CoGnitive Ortho-prosthesis. The project aims for the development of an artificial cognitive ortho-prosthesis system for the replacement of the lost lower limb of dysvascular transfemoral amputees and to provide assistance to the remaining sound limb. The final prototype will allow the amputee to walk, use stairs and move from sit-to-stand and stand-to-sit with limited cognitive and energetic effort. www.cyberlegs.eu

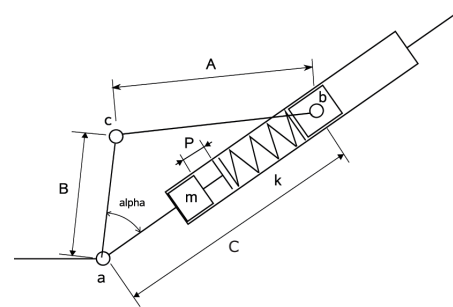

Figure 1: Configuration of a MACCEPA using rigid linkages. Compare to Figure 2

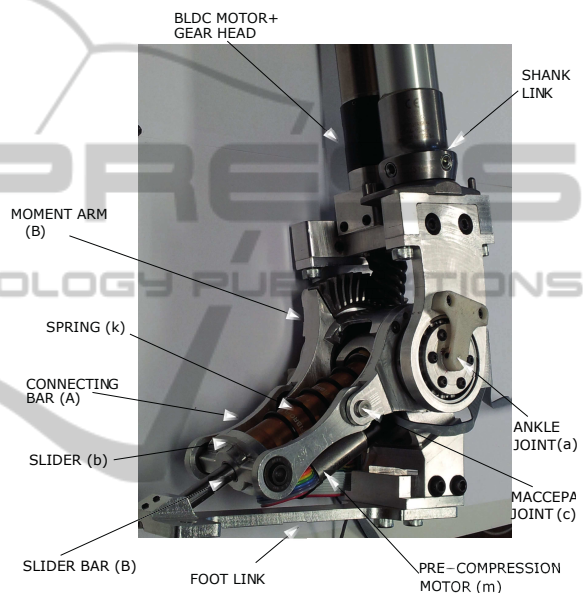

Figure 2: Implementation of the MACCEPA actuator.

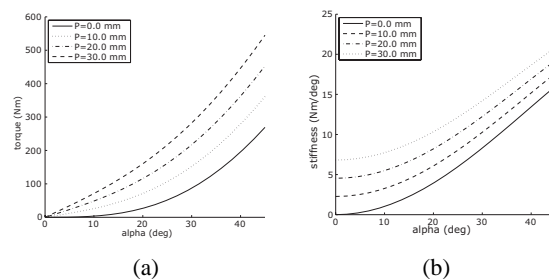

Figure 3: Torque and stiffness of the MACCEPA-design.

the entire normal joint torque and higher than previous designs by a factor of two.

The required motor power necessary to follow the desired torque trajectory was calculated by first identifying the required position of the moment arm, at every moment in time over a single step. The desired torque trajectory was determined from biomechanical data of healthy gait (Winter, D.A., 2005).

From the desired moment arm angle trajectory, the

desired moment arm velocity and power can be calculated. The spring constant and the pretension length were optimized to minimize peak actuator power, the main limiting factor in the size of the motor. Increasing the pretension length increases the peak power but the increased stiffness also greatly reduces the required motor velocity. The power, torque, and position characteristics required to track the typical biological ankle torque with the MACCEPA actuator are shown in Figure 4.

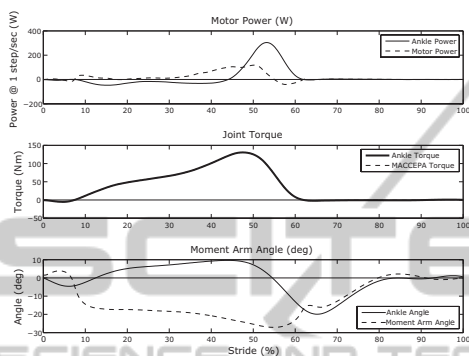

Figure 4: Power, torque and position characteristics of the MACCEPA actuator.

## 2.2 Knee

Knee behavior can be subdivided in two parts: first the weight acceptance phase, characterized by a high joint stiffness, and the flexion phase, where there is a high knee flexion of about 60° and a low torque to prevent the leg from extension during swing phase. The knee behavior can roughly be approximated by using two springs placed between the lower leg and the upper leg, shown by the red and green lines in Figure 5, respectively. A ratchet and pawl mechanism unlocks the stiff spring used for the weight acceptance so the knee can flex and provide sufficient ground clearance for the swing phase.

Joint torque approximation is not accurate with the combination of these two springs alone. Between the end of the weight acceptance and maximum flexion, a higher torque is needed around the knee joint to prevent the knee joint from collapsing during the push off phase. At this point, a second locking mechanism locks in another stiff spring, placed between the knee and the ankle. This energy transfer mechanism provides the necessary stiffness at the knee and, because it is also connected to the ankle, transfers stored energy to the ankle where it can be used for push-off. The realized knee design can be found in Figure 6.

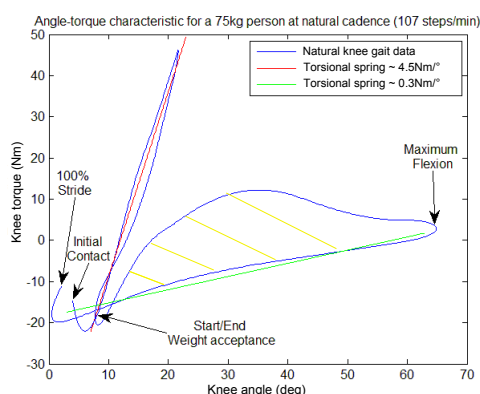

Figure 5: Approximation of the knee torques by using 2 springs.

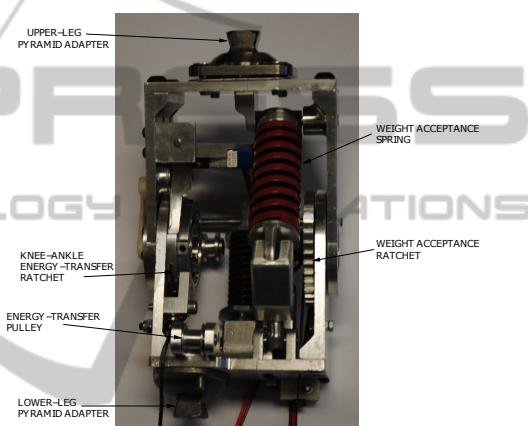

Figure 6: Back view of the prosthetic knee with two locking mechanisms. The baseline spring (blue) is on the front of the knee and is seen to the left of the weight acceptance spring (red).

## 2.3 Energy Transfer

During normal walking of an able-bodied person, a knee joint primarily dissipates energy (Winter, D.A., 2005) providing an opportunity to harvest this energy for use during a different part of the gait cycle. There are two times during the gait cycle which the knee mechanism attempts to collect and deliver to the ankle. These times are at the end of swing phase and during late pushoff, the combined energy of these two periods is displayed in the yellow shaded section of Figure 5.

Energy from the end of swing phase is captured in the baseline spring on the front of the knee. Then the coupling mechanism is locked during stance and pushoff, providing a direct kinematic constraint between the knee and the ankle. This kinematic constraint allows the torque generated by the baseline spring and the ankle-knee kinematic constraint to effectively transfer energy to the ankle at the end

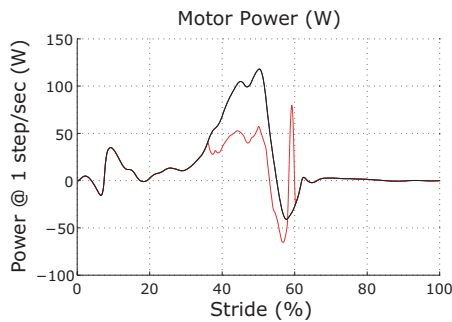

Figure 7: Motor power required to match the average ankle torque with (red line) and without (black line) energy transfer from the knee.

of pushoff. Transferred energy is delivered with a slightly delayed ankle push-off when compared to normal gait in order to transfer maximum energy. Because this energy is now provided at the moment where the ankle torque is the highest, there is a reduction in torque that the ankle actuator must provide. In Figure 7, the reduction in motor power due to the energy transfer mechanism required to match the average ankle torque is illustrated. The power peaks are lower and there is an overall drop in energy usage of about 30 % (7 J reduction compared to a total consumption of 22 J per step).

## 2.4 Control System

The control system runs on a real-time controller, a cRIO 9082 (National Instruments, Austin, Texas, US), endowed with a 1.33 GHz dual-core processor running a NI real-time operating system and a Field Programmable Gate Array (FPGA) processor Spartan-6 LX150. Ankle motors is controlled by means of commercial servos (Maxon EPOS2 70/10). A closed-loop PI controller is used to control the MACCEPA moment arm position. Control of the reference signal for the MACCEPA as well as for the locking-unlocking mechanisms is based on the estimates of the vertical ground reaction force and coordinates of the center of pressure gathered by means of two 64-channel pressure-sensitive insoles embedded into the sport shoes worn by the amputee (Donati, M. et al., 2013). This initial finite state machine control system is intended to only provide basic capabilities for testing purposes and will be later replaced by a novel hybrid control system based motor primitives and feedback reflexes.

## 3 RESULTS

Preliminary testing with both intact and amputated

limbs has proven successful. The prosthesis is currently undergoing a larger amputee trial, with results from these trials in the near future. Multiple control schemes translating the user motion intentions into motor commands for the prosthesis are being tested to incorporate the prosthesis within the larger CYBERLEGS framework.

As an initial study, we created a finite state machine using the input of the insole sensors to trigger gait state transitions. A sample dataset from an amputee subject can be found in Figure 8. Here we can see the gait state determined by the insoles as well as the desired and actual MACCEPA moment arm positions. Note that during these early trials the moment arm position was commanded to half of the full range of torque required by the ankle during normal gait. Even with these low ankle torques, we were able to achieve reasonable ankle and knee kinematics during the trials, and show a positive injection of energy at the ankle joint. In addition, the motor/gearbox combination used in these tests were much slower than the initial design suggested so that integration into the larger CYBERLEGS system could be expedited. This highly limits the moment arm velocity, although for these tests it did not prove to be a large issue, but must be addressed in the future.

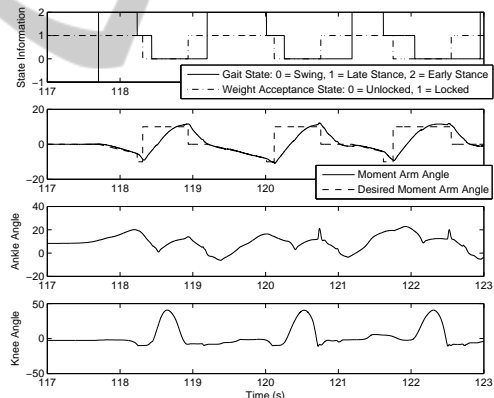

Figure 8: Preliminary dataset from the first prosthesis trials. Use of an early finite state machine with a conservative moment arm position with low torque.

## 4 DISCUSSION

A new transfemoral active ankle-knee prosthesis with energy transfer from the knee to the ankle has been presented. The device combines a novel ankle actuation design as well as a new knee-ankle energy transfer mechanism with the intention of reducing the energetic cost of both the user and the prosthesis. The current control system incorporates the use of pressure-sensitive foot insoles to determine the state of the gait



cycle on-line and control the knee and ankle modules, as well as their mechanical coupling. Recorded data and feedback from both healthy and amputated subjects showed promising performance and encourage a more extensive experimental characterization including the effect of pretension on the energetics of the gait cycle and the effects of the energy transfer mechanism. A powered knee based on the passive mechanism of this design is currently in development. This will allow sit to stand and stair climbing operations in addition to efficient walking.

## ACKNOWLEDGEMENTS

This work has been funded by the European Commissions 7th Framework Program as part of the project CYBERLEGs under grant no. 287894. The second author is funded by a Ph.D. grant of the Agency for Innovation by Science and Technology in Flanders (IWT).

## REFERENCES

- Au, S., Berniker, M., and Herr, H. (2008). Powered ankle-foot prosthesis to assist level-ground and stair-descent gaits. *Neural Networks*, 21(4):654–66.
- Au, S. and Herr, H. (2008). Powered ankle-foot prosthesis. *IEEE Robotics & Automation Magazine*, 15(3):52–59.
- Bellman, R., Holgate, M., and Sugar, T. (2008). SPARKy 3: Design of an active robotic ankle prosthesis with two actuated degrees of freedom using regenerative kinetics. *IEEE RAS & EMBS*, pages 511–516.
- Cherelle, P., Matthys, A., and et al. (2012). The AMP-Foot 2.0: Mimicking Intact Ankle Behavior with a Powered Transtibial Prosthesis. In *IEEE International Conference on Biomedical Robotics and Biomechatronics*.
- Donati, M. et al. (2013). A flexible sensor technology for the distributed measurement of interaction pressure. *Sensors*, 13(1):1021–1045.
- Herr, H. M. and Grabowski, A. M. (2012). Bionic ankle-foot prosthesis normalizes walking gait for persons with leg amputation. *Proc. Roy. Soc. Lon. B*, 279:457–464.
- Hitt, J. K., Bellman, R., and et al. (2007). The SPARKy Spring Ankle with Regenerative Kinetics project: Design and analysis of a robotic transtibial prosthesis with regenerative kinetics. In *ASME IDETC/CIE, Las Vegas, Nevada, USA*, pages 1587–1596.
- Hollander, K. W., Ilg, R., Sugar, T. G., and Herring, D. (2006). An efficient robotic tendon for gait assistance. *Journal of biomechanical engineering*, 128(5):788–91.
- IWalk (2013). Biom. <http://www.iwalk.com/>.
- Kaufman, K. R., Levine, J. A., and et al. (2008). Energy Expenditure and Activity of Transfemoral Amputees Using Mechanical and Microprocessor-Controlled Prosthetic Knees. *Archives of Physical Medicine and Rehabilitation*, 89(July):1380–1385.
- Matthys, A., Cherelle, P., Van Damme, M., Vanderborght, B., and Lefeber, D. (2012). Concept and design of the HEKTA (Harvest Energy from the Knee and Transfer it to the Ankle) transfemoral prosthesis. In *IEEE International Conference on Biomedical Robotics and Biomechatronics*.
- Ossur (2013). Power knee. [www.ossur.com](http://www.ossur.com).
- Sup, F., Bohara, A., and Goldfarb, M. (2008). Design and Control of a Powered Transfemoral Prosthesis. *International Journal of Robotics Research*, 27(2):263–273.
- Unal, R., Behrens, S. M., Carloni, R., Hekman, E. E. G., Stramigioli, S., and Koopman, H. F. J. M. (2010). Prototype Design and Realization of an Innovative Energy Efficient Transfemoral Prosthesis. In *IEEE RAS & EMBS*.
- Van Ham, R., Vanderborght, B., van Damme, M., Verrelst, B., and Lefeber, D. (2007). MACCEPA, the mechanically adjustable compliance and controllable equilibrium position actuator: Design and implementation in a biped robot. *Robotics and Autonomous Systems*, 55(10):761–768.
- Vanderborght, B., Bicchi, A., and et al. (2013). Variable Impedance Actuators : a Review. *Robotics and Autonomous Systems*, (Accepted June 2013):1–39.
- Villalpando, E. C. M., Weber, J., and et al. (2008). Design of an Agonist-Antagonist Active Knee Prosthesis. *IEEE RAS & EMBS*, pages 529–534.
- Winter, D.A. (2005). *Biomechanics and Motor Control of Human Movement*. John Wiley and Sons, United States of America.