

# PERFORMANCE ANALYSIS OF DIGITAL SLIDING MODE CONTROLLED INVERTERS

A. Fort<sup>1</sup>, M. Di Marco<sup>1</sup>, M. Mugnaini<sup>1</sup>, L. Santi<sup>1</sup>, V. Vignoli<sup>1</sup> and E. Simoni<sup>2</sup>

<sup>1</sup>*Dept of Information Engineering (DII), University of Siena, Via Roma 56, 53100, Siena, Italy*

<sup>2</sup>*Borri SpA Industrial Power Solutions, Bibbiena (Arezzo), Italy*

**Keywords:** Inverter, Sliding Mode Control, Sensitivity Analysis.

**Abstract:** This paper presents an analysis about the performance of bang-bang controllers used on a static machine for energy conversion (inverter) showing their robustness with respect to some key parameters and to some operating conditions. In particular a quasi sliding mode solution is proposed supported by sensitivity analysis able to allow the choice of proper operative parameters set for in field testing. Moreover a comparison between two different sliding surfaces proposal is presented.

## 1 INTRODUCTION

The problem of designing robust control solutions is a well known and discussed topic present in the literature both considering continuous (Tan, Lai and Tse, 2012; Young, Utkin and Özgüner, 1999) as well as discrete formulations (Gao, Wang and Homaifa, 1995; Jung, Dai and A. Keyhani, 2004; Marwali, 2004). Actually there are several papers which dealt with the use of such controllers in the discrete time domain applied to static conversion machines as inverters (Jung et al., 2004; Marwali, 2004; Wong, Leung and Tam, 1999; Gao, 1990; Hung, Gao and Hung, 1993; Gao and Hung, 1993). Taking into account, for example, the work of Wong et al. (1999), such approach is limited to the application of a solution without showing its characteristics of robustness according to the requirements of market regulation. Usually typical inverter static and dynamic tests are not carried out, limiting the possibility to argue on the effectiveness of the control strategy on actual machine implementation. Moreover in several works as in (Gao et al., 1995) the behavior of the selected sliding surface is not addressed in terms of sensitivity performance nor its behavior for commercial employment is somehow discussed. Starting from this points, the authors tried to compare two control solutions based on quasi sliding mode controllers (QSMCs) according to some peculiar usage characteristics that are well known in the inverter market with the final aim of

assessing some rule of thumb for the selection of the QSMCs parameters. Actually as declared by Tan et al. (2012) even if some works exist assessing the performance characteristics of non linear control systems applied to static machines, they are not focused on the design aspects and limited to some performance parameters. Such works of course are useful for the industrial side because provide a path which allow to exploit such proposal and control strategies in real life and not only from an academic standpoint even if some implementation aspects still are lacking. Some others among such papers as (Tan et al, 2012; Gao et al., 1995; Wong et al., 1999) stress instead the accent on the importance to keep constant, or set opportunely, the switching frequency of the controller to improve performance or try to set the roadmaps for correct controller switching. Nevertheless most of these works are focused on the design of continuous time controllers which are likely not to be employed in everyday world. So, starting from the work of Gao et al. (1995) and from the one proposed by Wong et al. (1999) the authors compared the performance of a discrete time QSMC with an extended version proposed relying on a higher order state description of the system of interest which seems to better fit both the market and designers requirements. The performance taken into account are the ones usually considered in the inverter market. Comments have been also carried out considering the behaviour of a general sample static machine in terms of sensitivity analysis with respect to some key parameters as switching

frequency, sliding surface parameters, quasi sliding mode band and system cutoff frequency under nominal conditions and during static and dynamic load variation.

## 2 INVERTER STRUCTURE

In Figure 1 a typical half bridge PWM inverter topology is sketched (Gao et al., 1995). The circuit is composed by two constant voltage sources  $V_s$ , a  $LC$  group, a resistive load  $R_L$  and a couple of IGBT acting as power switches. The two IGBT are controlled by a signal  $d(t)$  in counter phase, that is, when IGBT1 is closed IGBT2 is open and viceversa and the commanding signal determines the duty cycle of the PWM signal defined as follows:

$$d = \frac{t_{on} - t_{off}}{t_{on} + t_{off}} \quad (1)$$

The switching period is set as the inverse of  $d/(t_{on} - t_{off})$ . Such switching period should be smaller compared to the circuit time constant defined by the  $LC$  group (Gao et al., 1995). It can be easily shown that, in such a way, the output system voltage  $V_{out}$  is a function of  $d$  and  $V_s$ .

The parameters value for an inverter of 20kVA are written in Table 1, where the switching frequency of the IGBT can range typically from a minimum value of 5kHz up to 15kHz.

Table 1: Inverter circuit parameters.

Components	Values			
	$L$ [ $\mu H$ ]	$C$ [ $\mu F$ ]	$R_L$ [ $\Omega$ ]	$V_s$ [V]
Components	500	300	2.8	400

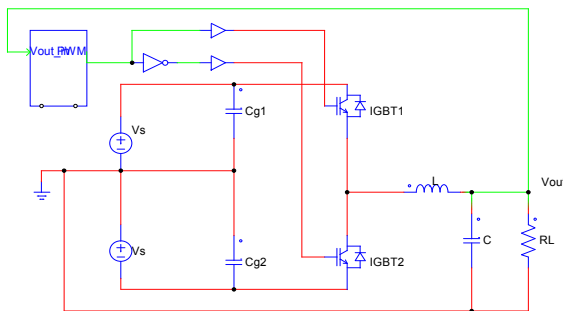

Figure 1: Closed control loop of an half bridge inverter topology.

The system state space, with  $d$  as control input and  $V_{out}$  as the output, can be written in the

continuous time domain as a classical state variable system:

$$\dot{x}(t) = A_{yz}x(t) + B_{yz}d(t) \quad (2)$$

where  $x$  is an  $n$ -vector and  $A_{yz}$  and  $B_{yz}$  are proper size matrices for the problem to be considered and  $y$  indicates whether the system is continuous or discrete, while  $z$  is the state order and  $d$  is a scalar.

By choosing the state as

$$x = \begin{bmatrix} v_c \\ \cdot \\ v_c \end{bmatrix} \quad (3)$$

where  $v_c$  is the voltage across the capacitor, it is possible to have a single loop feedback exploiting the capacitor ( $C$ ) voltage ( $v_c$ ) as output, assigning to  $A$  and  $B$  the following values:

$$A_{c2} = \begin{bmatrix} 0 & 1 \\ -\frac{1}{LC} & -\frac{1}{CR_L} \end{bmatrix}; \quad B_{c2} = \begin{bmatrix} 0 \\ \frac{V_c}{LC} \end{bmatrix} \quad (4)$$

Figures of merit of a commercial system as the one described should be within the limits of Table 2 in order to have a competitive features in the energy market.

Table 2: Commercial performance benchmark parameters.

Parameters for 20kVA	Values			
	THD <sup>(*)</sup>	Power Factor	Static load change	dynamic (0-100%) load change
	<2%	0.99	±1%	±5% <10 ms recovery time

(\*) These figures are in accordance with IEC6204-1-3 and are expressed for linear load in voltage instead of current

## 3 CONTROL THEORY AND DESIGN OF THE SWITCHING FUNCTION

### 3.1 Control Basics

The main concept of sliding mode control exploits the definition of a sliding surface and a proper set of parameters that enable such surface to become globally attractive for the system under consideration. Given the state-space representation (4), in order to derive a sliding mode control the sliding manifold:

$$S(x(t)) = 0 \quad (5)$$

should satisfy the following inequality

$$\dot{S}(x(t)) < 0 \quad (6)$$

while a suitable control law of the form:

$$d = \begin{cases} d^+ & S(x(t)) > 0 \\ d^- & S(x(t)) < 0 \end{cases} \quad (7)$$

should guarantee each state trajectory to converge to (5) (Tan et al., 2012; Young et al., 1999; Gao et al., 1995; Jung et al., 2004; Marwali, 2004; Wong et al., 1999; Gao, 1990; Hung et al., 1993; Gao and Hung, 1993).

In other words, equations (5) to (7) and the right choice of  $d$  assure that the state vector, starting from any initial condition, will slide up to the null solution.

A common choice for the reaching law, is given by Gao et al. (1995):

$$\dot{S}(x(t)) = -qS(x(t)) - \varepsilon \text{sgn}(S(x(t))) \quad (8)$$

where  $q$  and  $\varepsilon$  are positive quantities opportunely chosen in order to guarantee the system global stability.

### 3.2 Digital Control for Static Machines

The problem described in the previous section can be applied with suitable manipulations and assumptions to the discrete time case (DTC). Considering the discrete form of the system represented in (2), sampled at instant  $T_k$  (represented from now on as  $x(T_k) = x(k)$ ) it is possible to write (4) as:

$$x(k+1) = A_{dz}x(k) + B_{dz}d(k) \quad (9)$$

where  $A_{dz}$  and  $B_{dz}$  are the discrete forms according to classical system theory as argued by D'Azzo and Houpis (1995):

$$A_{dz} = e^{A_{cz}T_k}; \text{ and } B_{dz} = \int_0^{T_k} e^{A_{cz}T_k - \tau} B_{cz} d\tau \quad (10)$$

Together with the discrete time representation of the system the entire domain must be discrete. Some authors, among whom the first has been Hoft, suggested a discrete representation of the continuous time convergence law described by the following:

$$[S(x_{k+1}) - S(x_k)]S(x_k) < 0 \quad (11)$$

Other formulations, which result in a better implementation of the previous concept for discrete time controllers (DTC), are presented in the

literature (see, e.g., Gao et al. (1995) and references therein). A possible choice for the discrete-time form of (8) is:

$$S(k+1) - S(k) = -qT_s S(k) - \varepsilon T_s \text{sgn}(S(k)) = \phi(k) \quad (12)$$

where  $T_s$  is the switching period and the quantity  $qT_s$  must satisfy  $qT_s < 1$  in order to guarantee that, starting from any initial condition, the trajectories will move to the sliding surface.

### 3.3 System Switching Law

Once the reaching law is defined as per (12), a switching function should be chosen in order to let (7) in its discrete formulation to be a valid statement.

By selecting  $S(k)$  as a linear combination of the state variables:

$$S(k+1) - S(k) = 0 = \Phi_w^T x(k), \quad (13)$$

where  $\Phi_w$  is a vector of scalars of dimension ( $w$ ) it is possible to write (8) as:

$$\phi(k) = -qT_s \Phi_w^T x(k) - \varepsilon T_s \text{sgn}(\Phi_w^T x(k)) \quad (14)$$

and consequently (13) as:

$$\begin{aligned} S(k+1) - S(k) &= \Phi_w^T x(k+1) - \Phi_w^T x(k) = \\ &= \Phi_w^T A x(k) + \Phi_w^T B d(k) - \Phi_w^T x(k) = \phi(k) \end{aligned} \quad (15)$$

which, in turns, provides an expression for the switching law  $d(k)$ :

$$d(k) = -(\Phi_w^T B)^{-1} (\Phi_w^T A x(k) - \Phi_w^T x(k) - \phi(k)) \quad (16)$$

By replacing in (13) the state  $x(k)$  with the error  $e(k)$  among the state itself and a reference signal, it is possible to design a suitable sliding manifold for the systems as the one of Figure 1. Note that when the system moves on a sliding surface it behaves as a linear system approaching the null solution with time constants depending on the choice of the vector  $\Phi_w$ .

## 4 DIGITAL CIRCUIT CONTROL

Aim of this section is the design of the control law and the sliding manifold for the circuit described in Section I, according to (13). Using the output voltage error (with respect to a reference signal  $x_r(t)$ )  $e(t) = [x_r(t) - x(t)]$ : can be easily verified that the evolution of  $e_2(t)$  i.e.

$$e_2(t) = \begin{bmatrix} e(t) \\ e(t) \end{bmatrix} \quad (17)$$

obeys to (2) and (4). It is therefore possible to extend the state representation of (2) by defining matrices  $A_{c3}$  and  $B_{c3}$  as follows:

$$e_3(t) = \begin{bmatrix} \int_0^t e(\tau) dt \\ e(t) \\ e(t) \end{bmatrix}; \quad A_{c3} = \begin{bmatrix} 0 & 1 & 0 \\ 0 & 0 & 1 \\ 0 & -\frac{1}{LC} & -\frac{1}{CR_c} \end{bmatrix}; \quad B_{c3} = \begin{bmatrix} 0 \\ 0 \\ \frac{V_c}{LC} \end{bmatrix} \quad (18)$$

Since (2) and (18) admit their discrete-time counterpart, once they are replaced in (16), it is possible to design the control signal  $d(k)$ .

### 5 CIRCUIT PERFORMANCE: SENSITIVITY ANALYSIS

The circuit in Figure 1 has been simulated using PSIM 9.0.4 software and the system characteristics in terms of commercial performance of the two parameter sliding manifold have been analyzed. The nominal system parameters for simulations are: switching frequency of  $f_s=10\text{kHz}$ ; sampling frequency  $f_k=1\text{MHz}$ ;  $qT_s=0.25$ ;  $\varepsilon T_s=0.1$ ; sliding surface parameters for the 2D approach  $\Phi_2=(\Phi_1=1, \Phi_2=10^{-6})$ ; sliding surface parameters for the 3D approach  $\Phi_3=(\Phi_1=1, \Phi_2=1, \Phi_3=0,0625)$ . In Figure 2, 3 and 4 the system performance in terms of voltage THD% with respect to two dimensional manifold slope variation, system cutoff frequency ( $C$  only) variation and switching frequency variation have been reported, respectively. In Figure 5 it is shown how the system performance, during dynamic load variation (from 0-100% of the nominal load), can be slightly improved in terms of settling time changing the  $\varepsilon$  parameter which is justified by the change into the QSMC band. According to Figure 6 the static behaviour of the two parameters controller is generally worse with respect to the choice of the three parameters sliding surface while the two sliding controllers have almost the same dynamical

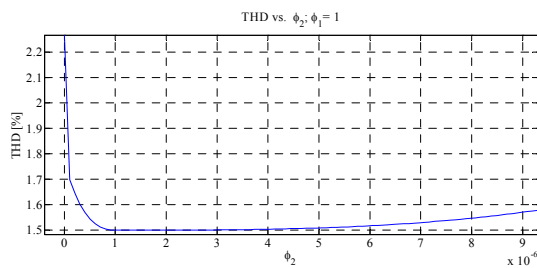

Figure 2: THD% variation with respect to the change in the slope of the QSMC in the 2D error state space.

behaviour which is generally better with respect to traditional PID systems (Gao et al., 1995).

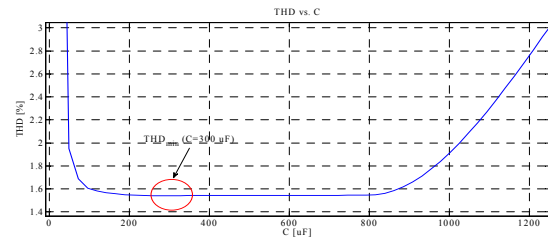

Figure 3: THD% variation with respect to the change into the system cutoff frequency. This is important from a design standpoint showing the possibility to reduce the weight and space occupation of such capacitor keeping the same performance.

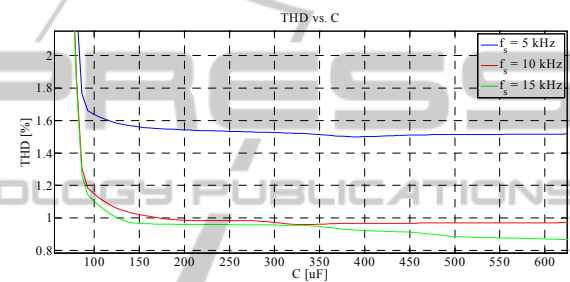

Figure 4: THD % variation with respect to  $C$  and evaluated a three switching frequencies.

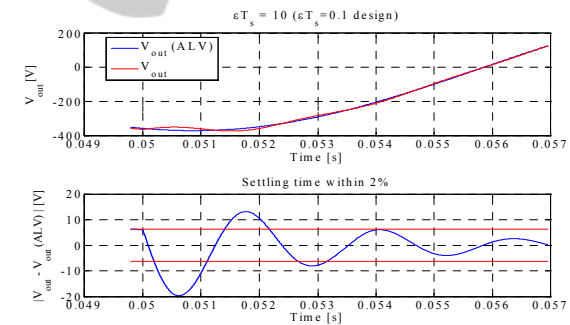

Figure 5: System dynamic response to load variation (0-100%  $V_{out}-V_{out}$  AVL after load variation) with  $\varepsilon$  parameter 100 times greater than the design one .

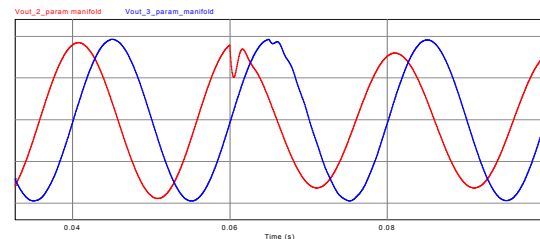

Figure 6: Comparison between systems performance (static behavior 0-100% load) with two parameters (red) and three parameters (blue) controllers. The phase shift has been magnified to make two picture easily comparable.

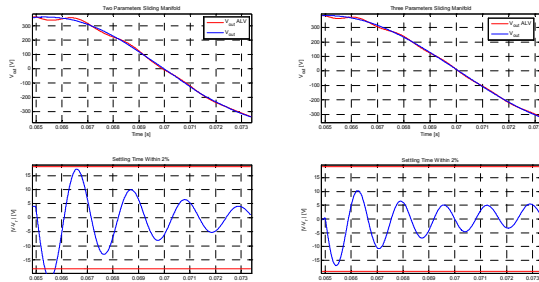

Figure 7: Dynamic behavior of the two parameter controller (left) with respect to the three parameters one (right).

## 6 CONCLUSIONS

In this work the authors, starting from an existing circuit model, have simulated the performance of two sliding manifolds applied to a commercial designed inverter of 20kVA. The authors identified that there are differences between control implementations that are evident upon static load variation and are less evident under dynamic ones.

Simulations have been carried out in order to minimize the chattering due to finite switching frequency (coping with actual implementation on IGBTs) and taking into account the possibility to act on the  $\epsilon$  parameter to control the admissible band.

## REFERENCES

- S. C. Tan, Y. M. Lai and C. K. Tse, 2012. *Sliding Mode Control of Switching Power Converters*. CRC Press.
- K. D. Young, V. I. Utkin and Ü. Özgüner, 1999. A Control Engineer's Guide to Sliding Mode Control. *IEEE Transactions on Control Systems Technology*, 7, 328-342.
- W. Gao, Y. Wang and A. Homaifa, 1995. Discrete-Time Variable Structure Control Systems. *IEEE Transactions on Industrial Electronics*, 42, 117-122.
- J. W. Jung, M. Dai and A. Keyhani, 2004. Optimal Control of Three-Phase PWM Inverter for UPS Systems. *35th Annual IEEE Power Electronics Specialists Conference*, 2054-2059.
- M. N. R. Marwali, 2004. *Digital Control Of Pulse Width Modulated Inverters For High Performance Uninterruptible Power Supplies*. PhD Thesis, Ohio State University.
- L. K. Wong, F. H. F. Leung and P. K. S. Tam, 1999. Control of PWM Inverter using a Discrete-time Sliding Mode Controller. *IEEE International Conference on Power Electronics and Drive Systems, PEDS'99*, 947-950.
- W. B. Gao, 1990. *Foundation of Variable Structure Control*. Beijing: China Press of Science and Technology.
- J. Y. Hung, W. B. Gao and J. C. Hung, 1993. Variable Structure Control: A survey. *IEEE Transactions on Industrial Electronics*, 40, 2-22.
- W. B. Gao and J. C. Hung, 1993. Variable Structure Control of Nonlinear Systems: A new approach. *IEEE Transactions on Industrial Electronics*, 40, 45-55.
- J. J. D'Azzo and C. D. Houpis, 1995. *Linear Control System Analysis and Design*. McGraw-Hill Higher Education.