

# INSTRUMENTATION FOR MINIMALLY INVASIVE MEASUREMENT OF VESICAL PRESSURE IN MEN

João Carlos Martins de Almeida

*School of Electrical and Computer Engineering, University of Campinas, Campinas, Brazil  
Center for Biomedical Engineering, University of Campinas, Campinas, Brazil*

Rodrigo Horikawa Watanabe

*School of Electrical and Computer Engineering, University of Campinas, Campinas, Brazil*

David Jacques Cohen, Carlos Arturo Levi D'Ancona

*Division of Urology of School of Medical Sciences, University of Campinas, Campinas, SP, Brazil*

José Wilson Magalhães Bassani

*School of Electrical and Computer Engineering, University of Campinas, Campinas, Brazil  
Center for Biomedical Engineering, University of Campinas, Campinas, Brazil*



**Keywords:** Urodynamics, Prostate, Vesical pressure, Instrumentation.

**Abstract:** Urodynamic assessment is important to evaluate bladder outlet obstruction (BOO), but the procedure is invasive, expensive and time-consuming, and is not free of complications (e. g. macroscopic hematuria, fever). In a previous work, we reported a new method developed for measuring vesical static pressure during urodynamic exams by using a device named urethral connector (UC). Clinical tests indicated that the new method is comparable to the conventional standard procedure with clear advantages. In this work, we describe improvements made on the UC, which confer greater autonomy and portability to the whole measurement system. We also report the results of clinical tests.

## 1 INTRODUCTION

Lower urinary tract symptoms (LUTS) are very common in elderly patients (Gomes et al., 2004). Many of these symptoms are related to bladder outlet obstruction (BOO) due to benign prostatic hyperplasia (BPH), which afflicts approximately 50% of men above 60 years-old (Power & Fitzpatrick, 2004). About 35% of the patients undergoing prostate surgery due to LUTS will not benefit from it because they do not have obstruction. Urodynamic assessment is the gold standard procedure (GSM) for detecting BOO; however, the procedure is invasive, expensive and time-consuming (Gomes et al., 2004).

Along the years, other methods have been proposed for minimally invasive urodynamic assessment (Pel & van Mastrigt, 1999; Griffiths et al., 2002; Parsons et al., 2009), each of them with advantages and disadvantages. As previously reported (D'Ancona et al., 2008), we have developed a new method (MUC, Method of the Urethral Conector) for minimally invasive measurement of the static bladder pressure. This variable, as well as void flow, have been used to categorize patients as non-obstructed, equivocal or obstructed (van Mastrigt et al., 2009; Clarkson et al., 2008; Harding et al., 2009). We have developed a relatively simple device named urethral connector (UC), which was tested clinically, and proved to be easy to use, while allowing detection of BOO in men

(D’Ancona et al., 2008).

Here we describe improvements made on the UC, as to confer autonomy and portability to the device and measurement system, and report clinical tests.

## 2 METHODOLOGY

### 2.1 Instrumentation

The UC is a device made of polyvinyl carbon and polytetrafluoroethylene, with a conic inlet tube (A in Figure 1) designed to fit the urethral meatus and fossa navicularis, as to avoid leakage during voiding through the device. In the present device a built-in pressure transducer (B in Figure 1, MPX2300DT1, 30  $\mu\text{V}/\text{mmHg}$ , Freescale Semiconductor, Austin, TX, USA) was included for measurement of the urine edge pressure on the outflow line. The output signal of the transducer was amplified (custom-made amplifier with variable gain and offset) and fed to a computer via NI USB-6215 interface (National Instruments, Austin, TX, USA). A Labview™ program was used for data acquisition and processing.

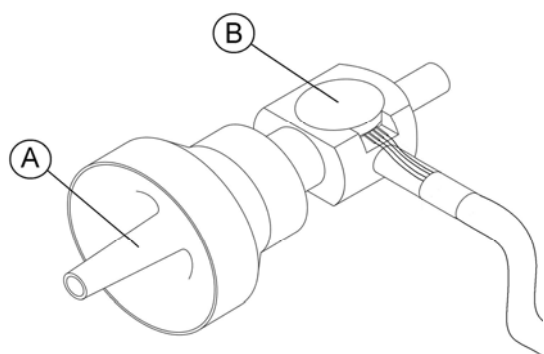

Figure 1: Urethral connector. (A), conic tube designed to fit the urethral meatus and fossa navicularis. (B) contains a pressure transducer for measuring vesical pressure.

For the transducer calibration, the amplifier offset and gain were adjusted so that when no pressure was applied to the transducer, the output voltage is zero, and application of 200  $\text{cmH}_2\text{O}$  results in an output of 5 V. Transducer calibration was performed with a pneumatic transducer tester (DPM-IB, Bio-Tek Instruments, Winooski) in the range of 0 to 200  $\text{cmH}_2\text{O}$ . This pressure range has been adopted by other investigators to test their minimally invasive methods (Griffiths et al., 2002).

Dynamic tests of the UC were performed using a

setup in which pressure gradient was generated by gravity, and the reference pressure values were obtained by manometry (Figure 2). These data were useful for determining part of the UC clinical procedure, as discussed further.

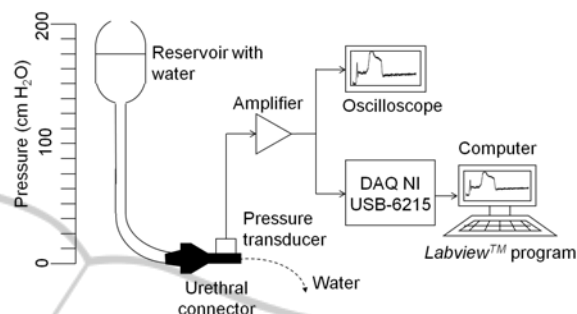

Figure 2: Setup used for bench-tests with the urethral connector. In dynamic tests, the UC was occluded so that the steady-state static pressure could be measured.

### 2.2 Clinical Tests

All the procedures were approved by the Committee for Ethics in Clinical Research of the University of Campinas (Protocol #1017/2008). The new system was tested successfully in 6 patients ( $66 \pm 2$  years old) with complaints of LUTS, after signature of a consent form. Patients underwent both the conventional and the minimally invasive (using the UC) urodynamic tests. Prior to the conventional urodynamic test, free flow uroflowmetry was also performed. Urine flow parameters, such as flow duration, time to reach maximum rate, maximum and average flow, and released urine volume were measured using a commercially available equipment (Urolite, Dynamed, São Paulo) in all patients during free uroflowmetry, GSM and MUC. For comparison between methods, we selected the parameters flow duration, maximum flow rate and urine volume.

The conventional urodynamic exam was performed using 6F and 8F urethral catheters, for measurement of vesical pressure and infusion of saline solution ( $37^\circ\text{C}$ ; 50 ml/min), respectively. The abdominal pressure was measured using a 6F rectal catheter. After reaching the maximal cystometric capacity and just before miction, the 8F catheter was removed, and the patient was oriented to empty his bladder. Urine flow, as well as vesical and abdominal pressures, were recorded with the Urolite equipment (Dynamed, São Paulo). Then saline solution was infused again until the maximal cystometric capacity was reached, and both urethral catheters were removed. The patient was instructed to introduce a previously sterilized UC (standard

ethylene oxide sterilization) into the urethra and to urinate through it. During miction, the UC outlet was manually occluded by the patient for a short period, allowing pressure recording by the developed system. Two alternatives were used: either the patient closed the UC outlet with his gloved finger, or a small flexible tube was connected to the output, allowing the patient to pinch it to produce a brief occlusion. For both methods (i.e., GSM and MUC), the patient was instructed to avoid straining. After the procedure, the patients answered a brief questionnaire about the exam. Data obtained from clinical tests were computed using the software Prism (Graphpad Software, San Diego, CA, USA).

### 3 RESULTS

Figure 3 shows the transducer calibration curve. Voltage output values (y-axis) were measured (10 replicates) for 9 different pressure levels (x-axis). Data were fit by linear regression ( $a = 0.024$ ;  $b = 0.032$ ;  $R^2 = 0.999$ ; values are expressed as mean  $\pm$  standard error.

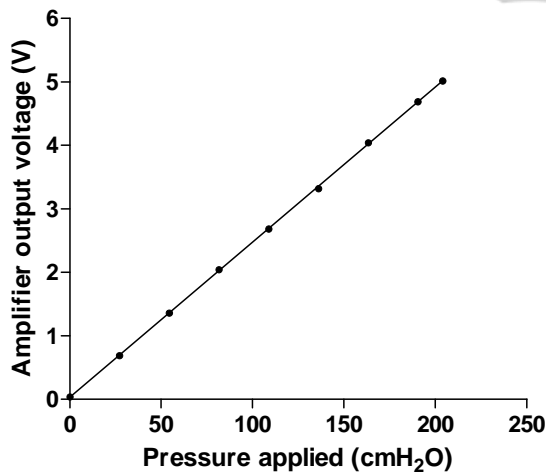

Figure 3: Calibration curve of the transducer. Applying 9 different pressure levels (x-axis) on the transducer, the output voltage (y-axis) of the circuit was measured. Data are means  $\pm$  SEM (N= 10). SEM values are 0.005-0.012 V, and thus not apparent in the figure.

Some dynamic tests were performed aiming at simulating aspects of the clinical procedure using the UC. The device was occluded in the following ways: instantaneously, as by an on-off solenoid valve, and gradually. The signals recorded are shown in Figures 4 and 5, respectively.

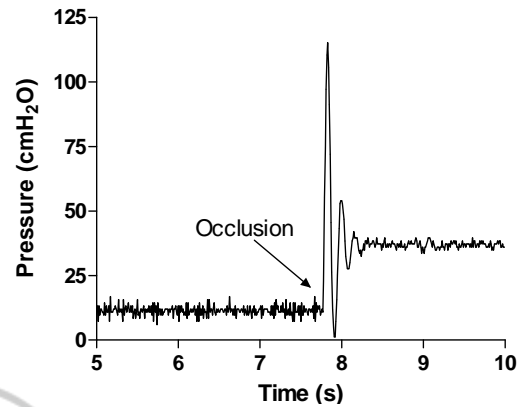

Figure 4: Simulation of aspects of the clinical procedure with instantaneous occlusion of the UC during continuous flow and constant pressure. The time to reach the maximum pressure was lower than 100ms. The initial abrupt pressure change is the hydraulic shock.

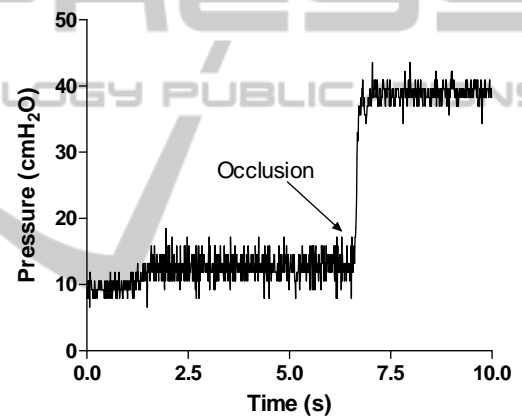

Figure 5: Simulation of a clinical procedure with gradual occlusion of the UC during continuous flow and constant pressure. The steady-state static pressure is not significantly different from that obtained as in Figure 4. Pressure rise time was about 300 ms.

Figure 6 illustrates the pressure recorded during a clinical procedure using the UC. The approximate moment of the UC occlusions is indicated by an arrow.

With the UC method, the maximum steady-state pressure value during an occlusion is considered as the value that best reflects the bladder contraction capability. In the conventional method, this pressure value is best measured at the maximal flow rate. The comparison of vesical pressure values recorded with both methods is shown in Figure 7. There was significant correlation between the measurements obtained with the two methods (Pearson  $r = 0.89$ ;  $R^2 = 0.802$ ;  $P < 0.015$ ;  $a = 2.00 \pm 0.49$ ,  $b = -37.00 \pm 36.78$ ), although absolute values could differ as much as 30%.

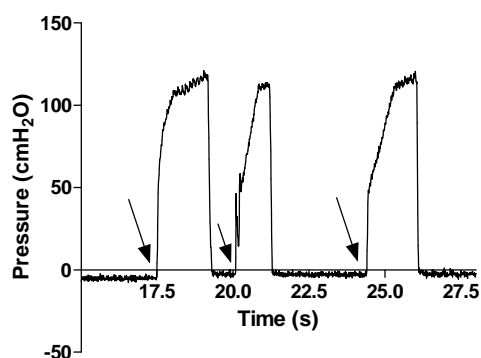

Figure 6: Pressure recorded during a clinical procedure using the UC. Arrows indicate the approximate moments of the UC occlusion. The steady-state static pressure after occlusion was ~122 cmH<sub>2</sub>O in this case.

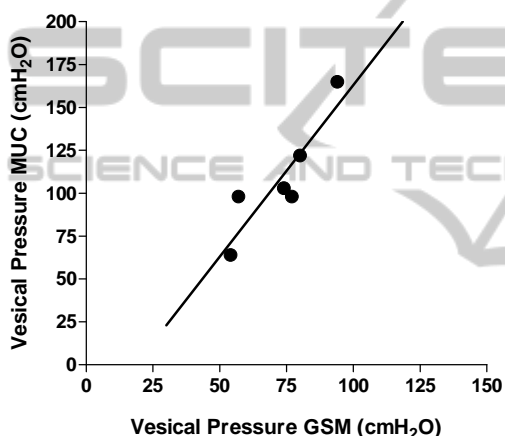

Figure 7: Regression line representing comparison of pooled data obtained from six patients using GSM and MUC.

Table 1 summarizes data obtained from uroflowmetry. Statistical differences between the two methods were not observed for flow duration, maximum flow rate and urine volume ( $P > 0.05$ ; Student's *t* test; Table 1).

Table 1: Uroflowmetry data (values are expressed as mean  $\pm$  standard error,  $N = 6$ ). The last line shows the *P* values obtained from the *t* test for comparison of the two methods.

Procedure	Flow duration (s)	Maximum flow rate (ml/s)	Urine volume (ml)
GSM	67.5 $\pm$ 12.9	6.7 $\pm$ 1.2	194.2 $\pm$ 39.3
MUC	72.9 $\pm$ 9.1	8.5 $\pm$ 1.5	199.5 $\pm$ 43.8
<i>P</i>	0.400	0.442	0.844

#### 4 DISCUSSION

The results from the bench tests have shown that the amplifier output is linear and reproducible ( $r^2 = 0.999$ ). Dynamic bench tests showed that it is possible to implement gradual occlusion of the UC (Figure 5) and that this seems to be the best approach for measuring the steady-state static pressure without causing hydraulic shock (see Figure 4), which results from abrupt flow interruption and may cause discomfort to the patient and/or damage to his urinary system.

As shown in Figure 6, in a typical clinical test using the UC, as the outflow is interrupted, pressure rises quickly to a steady-state value. This patient shows a clearly elevated bladder pressure that indicates there is some kind of disturbance in low urinary tract. In elderly patients, this disturbance is likely to be due to prostate enlargement. In this case, the patient was diagnosed as obstructed, according to the conventional method.

The steady-state static pressure recorded by using the UC is not expected to be identical to the pressure measured at the maximum flow as in GSM. However, a positive correlation between these pressures was observed (Figure 7), which indicates that MUC is also sensitive at detecting alterations of vesical pressure. Nevertheless, control reference pressure values recorded with the UC in healthy patients are still to be determined.

Flow is also a parameter used for diagnosis of infravesical obstruction. The absence of significant differences in the flow values measured with GSM and MUC is an indication that the UC seems not to impose a significant additional resistance to urine flow. It should be observed that both methods were applied at the same maximum cystometric capacity.

Other non-invasive methods for measuring bladder pressure are currently available (Pel & van Mastrigt, 1999; Griffiths et al., 2002). We believe that the present solution, allows more comfort to the patient during examination, as patients reported no pain or discomfort during clinical tests. Nevertheless, MUC showed to be at least as sensitive as GSM in the detection of alterations of vesical pressure. Further studies in equivocal and healthy subjects are being planned so that control reference values for vesical pressure may be determined.

#### 5 CONCLUSIONS

The developed device and measuring system is

portable, reliable and robust, allowing measurement of the static bladder pressure during voiding. The clinical results indicate that the MUC may be a promising minimally invasive alternative for clinical evaluation of vesical pressure.

## REFERENCES

- Clarkson, B., Robson, W., Griffiths, C., McArdle, F., Drinnan, M., Pickard, R. 2008. Multisite evaluation of noninvasive bladder pressure flow recording using the penile cuff device: assessment of test-retest agreement. *The Journal of Urology*. 180: 2515-2521.
- D'Ancona, C. A. L., Bassani, J. W. M., Querne, F. A. O., Carvalho, J., Oliveira, R. R. M., Netto Junior, N. R. 2008. New method for minimally invasive urodynamic assessment in men with lower urinary tract symptoms. *Urology*. 71: 75-78.
- Gomes, C. M., Arap, S., Trigo-Rocha, F. E. 2004. Voiding dysfunction and urodynamic abnormalities in elderly patients. *Revista do Hospital das Clínicas da Faculdade de Ciências Médicas da Universidade de São Paulo*. 59: 206-215.
- Griffiths, C. J., Rix, D., MacDonald, A. M., Drinnan, M. J., Pickard, R. S., Ramsden, P. D. 2002. Noninvasive measurement of bladder pressure by controlled inflation of a penile cuff. *The Journal of Urology*. 167: 1344-1347.
- Harding, C., Robson, W., Drinnan, M., McIntosh, S., Sajeel, M., Griffiths, C., Pickard, R. 2009. The penile cuff test: A clinically useful non-invasive urodynamic investigation to diagnose men with lower urinary tract symptoms. *Indian Journal of Urology*. 25: 116-121.
- Parsons, B. A., Bright, E., Shaban, A. M., Whitehouse, A., Drake, M. J. 2009. The role of invasive and non-invasive urodynamics in male voiding lower urinary tract symptoms. *World Journal of Urology*.
- Pel, J. J. M., van Mastrigt, R. 1999. Non-invasive measurement of bladder pressure using an external catheter. *Neurourology and Urodynamics*. 18: 455-475.
- Power, R. E., Fitzpatrick, J. M. Medical treatment of BPH: an update on results. 2004. *European Urology Update series*. 2: 6-14.
- van Mastrigt, R., Pel, J. J. M., Huang Foen Chung, J. W. N. C., de Zeeuw, S. 2009. Development and application of the condom catheter method for non-invasive measurement of bladder pressure. *Indian Journal of Urology*. 25: 99-104.