

DRIVING WARNING SYSTEM BASED ON VISUAL PERCEPTION OF ROAD SIGNS

Juan Pablo Carrasco, Arturo de la Escalera and José María Armingol

Intelligent Systems Lab. Universidad Carlos III de Madrid, c/Butarque 15, 28911 Leganés, Spain

Keywords: Road Sign Detection, Image Processing, Advanced Driver Assistance System, Road Sign Recognition, GPS Data, Tracking.

Abstract: Advanced Driver Assistance Systems are used to increase the security of vehicles. Computer Vision is one of the main technologies used for this aim. Lane marks recognition, pedestrian detection, driver drowsiness or road sign detection and recognition are examples of these systems. The last one is the goal of this paper. A system that can detect and recognize road signs based on color and shape features is presented in this article. It will be focused on detection, especially the color space used, investigating on the case of road signs under shadows. The system, also tracks the road sign once it has been detected. It warns the driver in case of anomalous speed for the recognized road sign using the information from a GPS.

1 INTRODUCTION

Security in vehicles is one of the areas of research where industry is investing more money. Governments are also very aware of the problem because of monetary and human reasons.

One way to deal with this problem is the implementation in vehicles of Advanced Driver Assistance Systems (ADAS), which increase safety in vehicles in several ways: adaptive cruise control, automatic parking, and those based on Computer Vision: pedestrian detection, drowsiness detection, lane mark detection or road sign detection and recognition (RSR). In this paper, a RSR system is presented. It will be able to detect and recognize yield, danger and prohibition road signs in real environments, warning the driver in case of inadequate speed for the recognized road sign. This will allow the driver to concentrate more on driving itself, increasing safety.

Detection of road signs is usually based on shape and colour features. In this case, yield, danger and prohibition road signs are red bordered, so first, the goal will be enhancement of the typical red color of these road signs in the image while filtering the others, obtaining a greyscale image where only the border of the road sign will appear. Fig. 1. Color information depends on the aging of the road sign, distance to it, weather conditions, shadows,

occlusions and camera limitations, so it is a difficult problem to deal with.



Figure 1: Left: RGB image of a road sign. Right: greyscale image where red pixels belonging to the border have been enhanced.

Different colour spaces can be used in this aim: RGB (Bahlmann *et al* 2005) is easily implemented but is very dependent of lighting changes. HSI, HSL, HSV (de la Escalera *et al* 2004), (Fleyeh 2004), (Vitabile *et al* 2004), are very similar and commonly used since the Hue component does not vary too much under distance or illumination changes. Some authors do not find colour segmentation reliable so prefer to use greyscale since it is invariant to the illumination changes and shadows (Soetedjo and Yamada 2005).

Once the road sign is detected, it must be recognized. In this stage, neural networks (García-Garrido *et al* 2006) are used because of their flexibility, since they can deal with occlusions, rotations or road sign aging; but they have the disadvantage of a high computational cost.

Normalized correlation (de la Escalera *et al* 2004), (Betke and Makris 2001) allows fast algorithms implementation, obtaining high scores in detection and recognition. The drawback is that it depends too much on the models used to correlate in the image and on the image quality.

When the road sign is detected and recognized, it is a further step to track it. Although it supposes an increase in time (Maldonado-Bascon *et al* 2007) it allows to ensure the recognition since a data base with the number of recognitions and frames without (not in every frame the road sign is detected, due to the problems commented above), allows to store the state of the road signs recognitions. Kalman Filter has been the basic tool to perform this task (Maldonado-Bascon *et al* 2007) although it needs a linear model to converge to a good solution.

To provide useful information is one of the most important goals in the research of ADAS. In this way, the RSR systems should not only be able to recognize the different road signs but to filter the information useful for the driver, for example using the speed as one important data to limit the warning messages to the driver.

This paper is organized as follows: section 2 presents the system architecture; section 3 describes the research in detection; section 4 presents the recognition stage and in 5 the tracking. Finally, results will be given in section 6 and conclusions in 7.

2 SYSTEM ARCHITECTURE

The system presented in this paper fulfils the requirements of an ADAS in order to get a real time RSR system (Carrasco *et al* 2007).

It is able to detect, recognize and track red border road signs. It deals with one of the major problems in detection: the change in color when the road sign is under shadows, and a parallel study of the color of bricks is done in order to avoid them from the enhanced image. They are usually an error source due to their color similarity to road signs.

While the recognition application is working, another module gets information from the GPS to be used in the tracking stage and in the warning stage Fig.2. In this last case, if real speed of the vehicle, obtained from the GPS is inadequate for the recognized road sign, a message will be sent to the driver in order to reduce the velocity.

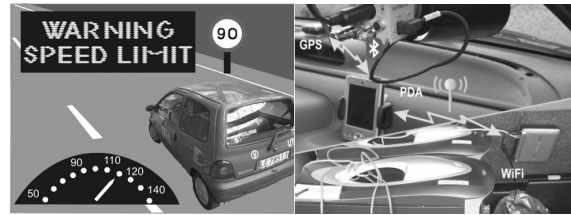

Figure 2: Left: GPS-RSR System. The system compares speed and road sign and warns the driver when necessary. Right: GPS Data acquisition module. A GPS device, a PDA and a PC with Wireless connection.

Fig 3. depicts the flow chart of the applications. It has two threads: The first one is in charge of getting data from the GPS. It is stored, validated and finally broadcasted to the PC. The other thread is the Computer Vision application. It acquires images, converts the image to adapt it to the requirements of the normalized correlation and finally, detects, recognizes and emits a message if necessary.

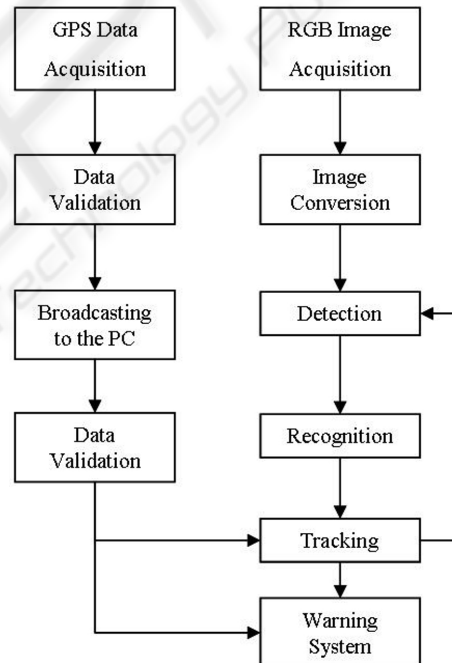

Figure 3: Flow chart of the GPS-RSR application. One thread communicates to the GPS to obtain and send data. The other is the Computer Vision application.

GPS data acquisition allows obtaining information that will be used in tracking and warning stages. The GPS device sends data by bluetooth connection to a PDA where an algorithm obtains it, validates it and broadcasts it to the PC (where the vision application is running) via WiFi.

GPS data follows the National Marine Electronics Association (NMEA) (NMEA 2007), based on several messages that contain different information. The PDA stores data from the different messages till there is validated information to form a string that will be sent to the PC. Validation is based on the number of satellites available, the information stored belongs to the same time and all the fields are filled with no null data. There, data is checked so no data is lost in the transmission.

From the whole information that can be taken from the GPS messages, speed, course and time are the ones used in the tracking stage and speed also in the warning stage.

3 ROAD SIGN DETECTION

In the detection stage, the system uses normalized correlation to find the possible road signs. This technique needs models of the road signs to correlate in an adequate image Fig. 4. This image is converted to greyscale through enhancement of the red color of the road signs to obtain a greyscale image (pure red is given the value 255=white, and absence of red is given the value 0=black). On this image, it will be possible to find the shape of the road sign as seen in Fig. 1.

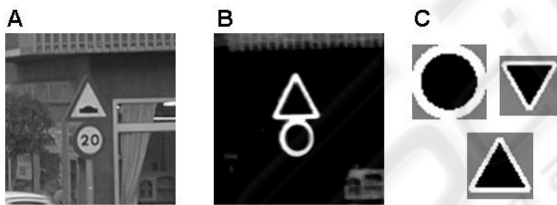

Figure 4: A) RGB image. B) Greyscale image after enhancement operation. C) Samples of models used in correlation over image B).

Danger, yield and prohibition road signs are red bordered, but due to aging, weather conditions or shadows, these borders may be not as red as they should. A data base of borders under real conditions has been used to model the behaviour of the color borders under sun or shadow, and the spectra of building bricks has been included, to study the possibility of avoiding them from appearing in the greyscale image. If in it there are only pixels belonging to the road signs, it is easier to find them and no confusion between them and bricks occur.

To achieve this goal, several images containing road signs have been stored. They have been separated into two groups: road signs under sun and

under shadow. The reason is that the red color under shadows changes considerably, enlarging its spectra to blue and green. So it is better to study sun and shadow effects separately.

Although this separation is arbitrary in uncertain cases, it will be proved that does not affect the final results of the study.

Conversion from RGB to HSL is then applied in order to decrease the effect of illumination changes in the road signs. Once they have been converted, the borders are manually cut off in order to work only with them. After this operation, for each pixel of the border, a statistical study of its H and S component values was performed Fig.5 and 6.

Enhancement is then solved in two ways: using the information of the components H and S together and using H and S separately.

The same work was done in the case of bricks, cutting of walls of red brick buildings in order to have a considerable data base of them for the experiments.

In the case of the two components, Hue and Saturation are used to obtain the probability of a pixel belonging to a pair (H, S). Fig. 5 shows the regions where borders under shadows, sun, and the case of bricks can be found. The experiment has been done under the premise that every border has to be found, so low probability H, S cases are also included. Results for the case of using H separately from S are in Fig. 6.

It can be seen in the Fig.5 that the regions overlap covering in part each other, so it is not possible to use these regions separately to isolate borders from bricks.

In the case of using H separately from S (Fig. 6), it can be seen for saturation, that shadows and bricks have nearly the same behaviour, while the sun gets it maximum in mid to mid-high saturation values. Then, it is not possible to separate bricks and borders only with this condition. Using only hue, shadows cover the sun region, and for low hue values the probability of red is very low while the one related to bricks is very high, so it behaves as a filter. Therefore, bricks are not going to get high grey values (255), part of the bricks are going to be avoided while no shadow or sun borders are going to be missed.

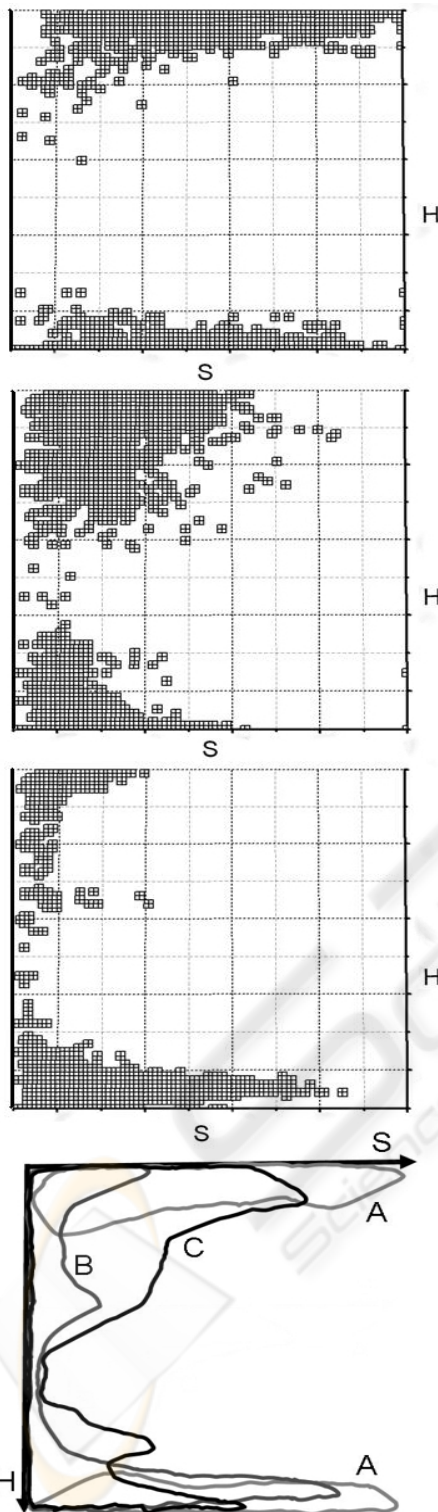

Figure 5: from top to bottom: (H, S) graphs for borders under sun, borders under shadows and bricks. The last one depicts the overlapping of the three. Line A stands for sun, B for bricks and C for shadows.

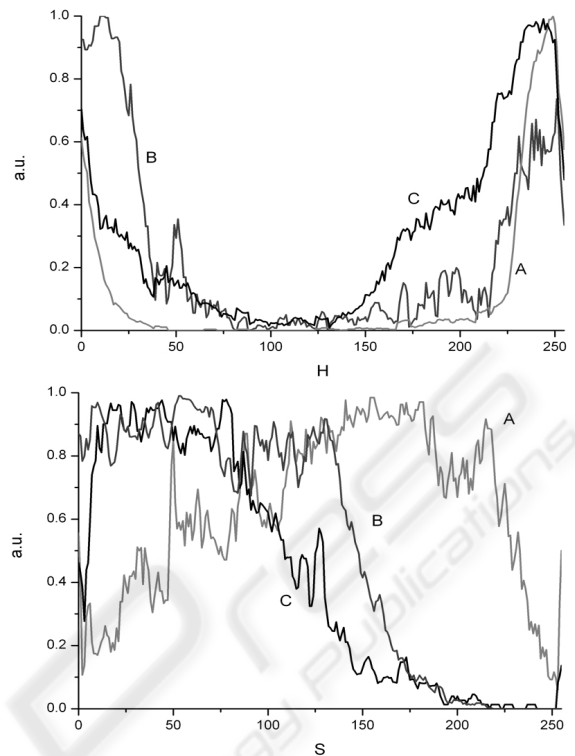

Figure 6: Hue and Saturation Graphs. Line A corresponds to borders under sun, B to bricks and C to borders under shadows.

4 RECOGNITION AND WARNING SYSTEM

In the recognition stage (Fig. 7), road sign candidates are converted to grayscale to partly help avoid illumination changes. After this, a resize operation is applied to obtain models of the same size that will be used to correlate over a template that contains all possible road signs. Each class (Yield, Danger and Prohibition) has its own road sign class template in order to reduce the false recognitions and decrease time of execution. Normalized correlation is used again and road signs with a score over a determined threshold will be considered as positives recognitions. Once the vision system recognizes a road sign, the warning system takes the speed given by the GPS and decides whether it is necessary to send a message to the driver or not.

The system warns the driver in the following cases: 1) A speed limit road sign is recognized and the speed is over the limit. 2) A danger or yield road sign is recognized and the speed is over a threshold set by the user. In these cases a written message



Figure 7: Recognition and Warning Stages. A) Detected road signs. B) Candidates to road signs. C) Recognition over the template. D) Output of the RSR system: shows the road image, the recognized road signs and E) its reliability level.

appears on the screen and a warning message is broadcasted by the vehicles' loudspeakers. A deeper explanation of these stages can be found in (Carrasco *et al* 2007).

5 TRACKING

Tracking is one of the last tasks incorporated to the recognition systems. It allows prediction of the position of the road sign frame by frame. This will be used to assure the positive recognition and avoid multiple successive warnings to the driver, fact that could cause disturbance to the driver instead of help. In this stage, information of the GPS is also used. It provides data as course, real speed and time that will be used to predict the position of the next detection of a previously recognized road sign. Knowing the size of the real road sign (norma 2000) an estimation of the next placement of the road sign on the image can be done. This allows taking into account the number of recognitions of a road sign, knowing that it corresponds to a single road sign. It may happen that in a frame there is no detection; the system would wait a fixed number of times to consider that the road sign is not going to appear again. If it finally appears, it can be taken as the same detection as before and not as a new one. Fig. 8 depicts the movement of the vehicle and the magnitudes involved in the tracking. In the appendix, equations

used for the estimation of the points of the world location and the screen are presented.

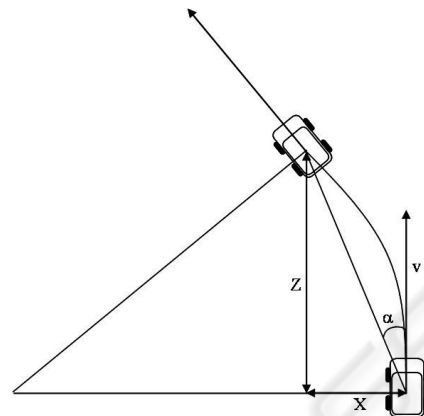

Figure 8: Movement of the vehicle. X stands for the change of distance in the X axis between two frames, once a road sign is recognized. Z is the distance covered by the vehicle between two frames. v is the linear speed given by the GPS, and α the change in the course angle between one position and the next.

6 RESULTS

In the detection experiments, ROC curves have been used (Fig.9) as well as different sequences of images modelled with the two detection configurations (H, S) and H. In the two cases the balance between false positives and true positives is quite good: the area under the ROC curve for the case of two components is 0.86 and for Hue-shadows 0.84, being 1 the ideal value. But in the case of the use of the single H in the shadow configuration, 9% more of positive detections is achieved. Better results could be obtained filtering situations of very low likelihood since they amplify the spectra of color, provoking an increase of the enhanced pixels that with high probability will not belong to an object of interest.

Through tracking equations, a region of interest is established allowing useful data to be obtained for the warning system. The main drawbacks are the low acquisition data given by the GPS (1 Hz), the need of a great number of models to correlate in the image in order to rise accuracy, and the problem of tracking in curve courses. Fig. 10 depicts a sequence in which it can be seen that fewer models are needed in the estimated region, because of the information predicted.

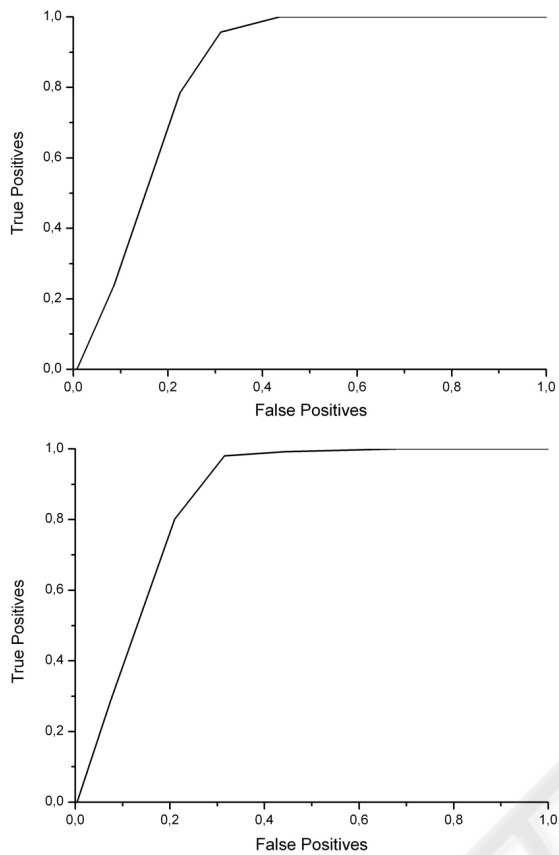

Figure 9: ROC curves for the two components (H, S) and H for shadows, from top to bottom.

The warning system gives useful information to the driver, filtered by the tracking stage, so it fulfils the requirements of an ADAS, limiting the useful data to that the driver needs to keeps a safety driving.

7 CONCLUSIONS

A RSR system has been presented which deals with the main tasks a system of this kind must fulfil. It has been shown that *a priori* it is not necessary to use two components for red color enhancement. A first approximation to the tracking of a road sign through GPS data has been shown. The method uses information from a GPS to predict the position of a road sign in subsequent frames after recognition.

This system has been implemented and tested in the experimental platform IVVI (islab 2007).

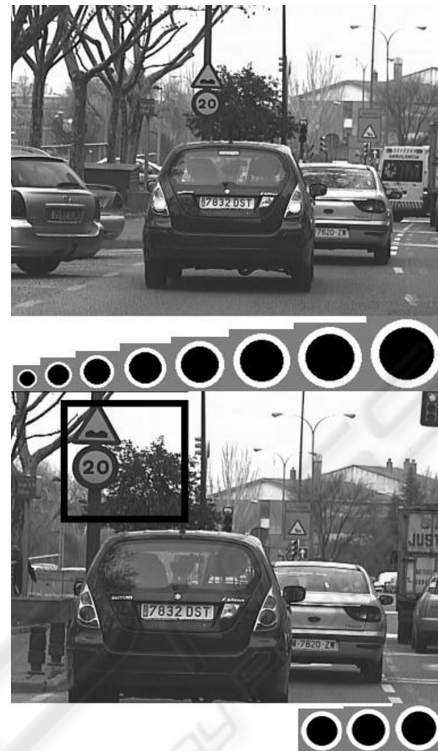

Figure 10: Example of tracking. In the first frame all the model are used. In the second, after prediction, only a few models in a little region are needed to detect the road sign.

(Intelligent Vehicle based on Visual Information) (fig. 11). This vehicle allows testing under real conditions, which validates the results. IVVI is also equipped with a driver tracking system, lane marks detection and classification system and a pedestrian detector system.



Figure 11: From left to right: CPU's where ADAS algorithms run. Keyboard and control screen. Experimental platform IVVI. Color camera, GPS and PDA.

ACKNOWLEDGEMENTS

This project is supported by the Spanish Government through the project TRA2004-07441-C03-01.

REFERENCES

- Bahlmann, C., Zhu, Y., Visvanathan, R., Pellkofer, M., Koehler, T., 2005. A system for traffic sign detection, tracking, and recognition using color, shape, and motion information. *Proceedings of the Intelligent Vehicles Symposium*. 255 – 260.
- Betke, M., Makris, N., 2001 Recognition, Resolution, and Complexity of Objects Subject to Affine Transformations. *International Journal of Computer Vision*. 44(1). 5 – 40.
- Carrasco, J.P., de la Escalera, A., Armingol, J.M.^a, 2007 Speed supervisor for intelligent vehicles. *11th Int. Conf. On Computer Aided Systems Theory, EUROCAST 2007*, LNCS 4739, 1175 – 1182.
- de la Escalera, A., Armingol, J.M., Pastor, J.M., Rodriguez, F.J., 2004. Visual sign information extraction and identification by deformable models for intelligent vehicles. *IEEE Transactions on Intelligent Transportation Systems*. Volume 5, Issue 2, 57 – 68
- Fleyeh, H.: 2004. Color detection and segmentation for road and traffic signs. *IEEE Conference on Cybernetics and Intelligent Systems*, Volume 2. 809 – 814.
- Garcia-Garrido, M.A., Sotelo, M.A., Martin-Gorostiza, E., 2006. Fast traffic sign detection and recognition under changing lighting conditions. *Proceedings of the IEEE Intelligent Transportation Systems Conference*. 811 – 816.
- islab. www.uc3m.es/islab september 2007.
- Maldonado-Bascon, S., Lafuente-Arroyo, S., Gil-Jimenez, P., Gomez-Moreno, H., Lopez-Ferreras, F., 2007. Road-Sign Detection and Recognition Based on Support Vector Machines. *IEEE Transactions on Intelligent Transportation Systems*, VOL. 5, Issue 2, 264 – 278.
- NMEA. www.nmea.org september 2007.
- norma 2000. Señalización vertical: Instrucción de carreteras Norma 8.1-IC. *Dirección General de Carreteras. Ministerio de Fomento*.
- Soetedjo, A., Yamada, K., 2005. Traffic Sign Classification Using Ring Partitioned Method. *IEICE Transactions on Fundamentals of Electronics, Communications and Computer Sciences*, VOL. E 88-A, NO.9 2419 – 2426.
- Vitabile, S., Gentile, A., Siniscalchi, S.M., Sorbello, F., 2004. Efficient Rapid Prototyping of Image and Video Processing Algorithms. *Euromicro Symposium on Digital System Design*. 452 – 458.

APPENDIX

Taking into account the model given in Fig. 6, equations for tracking based on GPS information are the following:

$$Z_w = \frac{F \cdot f \cdot RS_w}{RS_{mod}} \quad (1)$$

$$X_w = \frac{Z_w(x_i - x_0)}{F \cdot f} \quad (2)$$

$$Y_w = \frac{Z_w(y_i - y_0)}{F \cdot f} + C_w \quad (3)$$

Where Z_w , X_w and Y_w are the usual coordinates of the world in the euclidean space for the real road sign. F is the factor conversion px-mm of the CCD; f is the focal length, RS_w the size of the real road sign, RS_{mod} the size of the road sign on the screen, x_i and y_i coordinates of the screen; x_0 and y_0 the center points of the screen and C_w the height of the camera from the ground.

Once α , differential course angle; v , speed and t , lapse between two frames are obtained, it can be calculated:

$$d_z = \frac{vt}{2\alpha} \sin(2\alpha) \quad (4)$$

$$d_x = \frac{vt}{2\alpha} (1 - \cos(2\alpha)) \quad (5)$$

Therefore, estimation is:

$$Z_e = Z_w - d_z \quad (6)$$

$$X_e = X_w - d_x \quad (7)$$

Where the sign of d_x will depend on the course of the vehicle. Y_e is not estimated now since it is supposed to be a constant independent of distance or vehicle movement under the assumption of flat ground condition and movement by the y axis is negligible.