

Management Information System: Socio-economic Welfare Criteria of the Residents

Masna Wati¹, Muhammad Rizal¹, Andi Tejawati¹, Edy Budiman¹ and Niken Novirasari¹

¹Department of Computer Science and Information Technology, Mulawarman University, Samarinda, Indonesia

Keywords: Socio-economic, Information System, Welfare, Poverty.

Abstract: The need for data on the distribution of criteria for community welfare is very important to use to assist local governments in alleviating poverty and welfare problems. Therefore, this study aims to develop a criteria distribution information system. The Information System of the socio-economic conditions of the community was built using the Laravel framework and using 13 criteria divided into 47 sub-criteria sourced from the results of the SUSENAS Statistics Indonesia, East Kalimantan Province. The results achieved from this study are information systems that store data on the distribution of community welfare criteria as many as 295 data presented in the form of bar graphs and circle graphs.

1 INTRODUCTION

The phenomenon of poverty always arises and messes many developing countries (Kasri, 2016) (Swastika and Supriyatna, 2016). Since decentralization and regional autonomy is implemented, Indonesian local governments have an important mission in poverty alleviation and social services (Fossati, 2019). Poverty and inequality are problems faced by each local government (Budiman et al., 2017). The regional government has promoted several programs and efforts to overcome these problems, including the regional government of Samarinda (Maffirotin et al., 2018).

Based on the data from the Statistics Indonesia (BPS) of East Kalimantan Province, the population of Samarinda City in 2017 was 843,446 people. The data denote that the number of poor family in 2016 is 38.95 thousand people (4.72%) and in 2017 is 40.1 thousand people (4.77%) (Badan Pusat Statistik BPS. (BPS, 2017) . From these data, it can be seen that the number of poor people has increased from the previous year by 0.5%.

The analysis of the socio-economic welfare conditions of the community is very necessary to describe the level of socio-economic welfare the residents in the field based on the criteria that influence it. The social assistance programs launched by the government have targeted and relevant manner. Therefore, there is needed to know the socio-economic conditions of the population in each district to facilitate the decision of the government or private to their distribution

of social assistance programs.

Currently, the process of distributing government social assistance to the community starts with the data collection, selection, and recommendation process carried out by neighborhood leader. This recommendation is submitted to the village chief and subsequently used as the poverty data by the sub-district or the agency that organized the assistance program. An information system is a better solution for presenting data on the socio-economic welfare of the community and to mapping the distribution socio-economic welfare criteria of the population. This information system model will certainly provide data that describes the condition of the community so that it can be used as a reference in policy making by the local government so that the social assistance programs launched is on target or in other words it as needed of community (Ependi, 2012). The data of criteria distribution of community welfare can also determine the policy direction for the regional government in other programs to alleviate poverty and increase the welfare of the population.

2 RESEARCH FRAMEWORK

2.1 Socio-economic Welfare

Socio-economic welfare means good condition, happiness, and prosperity (Sururi, 2017). Community

welfare is the procedure of a social, material and spiritual livelihood that is rounded by a sense of safety and inner and outer peace that can go up for every citizen to fulfill physical, spiritual, and social needs for ourselves, families, and society. This study tried to build an information system to provide information about the condition of community welfare where the criteria used to describe the condition of the community based on the criteria used in the national socio-economic survey (SUSENAS), Statistics Indonesia, consisting of:

1. Monthly Expenditure per Capita
2. Occupation of a family head
3. Education Level
4. Home-ownership
5. Floor Area
6. Roofing Materials
7. Wall Materials
8. Floor Materials
9. Available capacity electricity
10. Water Source
11. Sanitation facilities
12. Cooking Fuels
13. Own a Car

2.2 System Design Model

UML (Unified Modelling Language) is a collaborative methodology of OOSE (Object-Oriented Software Engineering), OMT (Object Modelling Technique), and several other methods, which are the most frequently used methodologies for an analyze and design systems with methodologies object-oriented adaptation to the widespread use of the language "object-oriented programming" (OOP) (Gajewski, 2004)(Thiel et al., 2005)(Nugroho, 2009). In this study, software that was built using object-oriented programming languages. The system design model is presented in Figure 1-3.

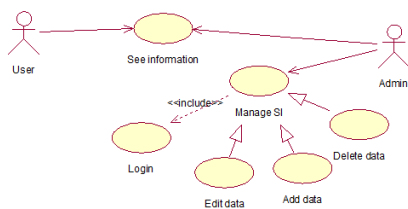

Figure 1: Use case diagram of software.

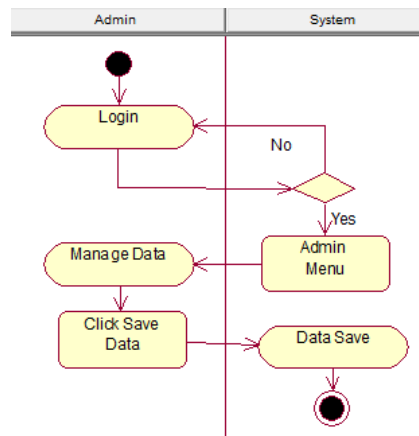

Figure 2: Activity diagram of software

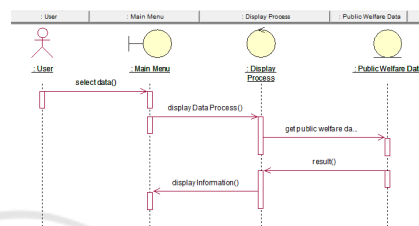

Figure 3: Sequence diagram of software

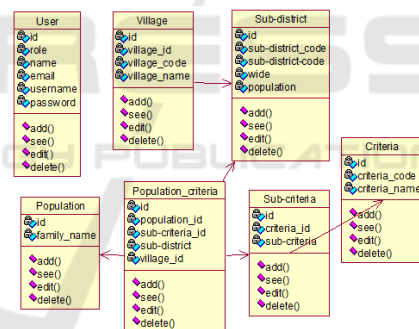

Figure 4: Class diagram of software

3 RESULT AND IMPLEMENTATION

Information System socio-economic conditions of the community are built using the Laravel framework and web-based. This information system is built to put on information on the data deployment of community welfare criteria displayed in the form of bar and circle graphs (pie). Bar charts display the distribution of sub-criteria and population per year. The pie chart displays the comparison of population data distribution based on criteria per sub-district.

This study uses 295 data and 13 criteria which are divided into 47 sub-criteria from the results of the National Socio-Economic Survey (SUSENAS) by the

Statistics Indonesia, East Kalimantan. The criteria are presented in Table 1.

Table 1: Criteria of socio-economic condition

Criteria	Sub-criteria
Monthly Expenditure per Capita	> 1.610.620 IDR
	≥ 1.000.000 IDR
	< 1.000.000 IDR
Occupation of a family head	Self-employed
	Small business owner
	Entrepreneur
	Labour / Employee
	Freelancer
Education Level	Non-graduate / Equivalency education for elementary
	Primary School
	Middle school
	High school
	Associate degree
	Bachelor's/ master /doctoral degree
Home-ownership	Own house
	Rent
	Rent-free
	Official house
Floor Area	> 100 m2 (large)
	≥ 50 m2 (medium)
	< 50 m2 (narrow)
Roofing materials	Concrete
	Roof tile
	Asbestos
	Zinc
	Wood / Shingle
Wall Materials	Brick
	Wood / Board
Floor Materials	Tile flooring
	Stone flooring
	Wood flooring
	Cement / red Brick flooring
Available capacity electricity	Non Electricity ;900 Watts
	Using 900 Watts
	Using > = 1300 Watts

System implementation is the stage of exhibiting data on the condition of public welfare level based on criteria in Table 1 in the design of a web-based information system built with Laravel framework. The

Water Sources	Water supply network Shallow wells / deep wells Surface water
Sanitation facilities	Have a toilet Public sanitation
Cooking fuels	LPG 12 Kg LPG 5.5 Kg LPG 3 Kg Kerosene Firewood
Own a Car	Yes No

interface of the information system socio-economy of community welfare that has been built is presented follow.

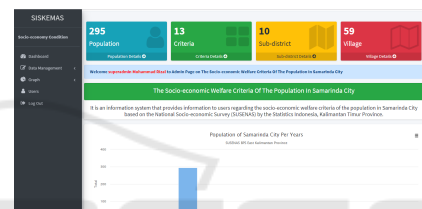

Figure 5: Home page interface

The home page interface of the system built is shown in Figure 5. In this interface information is provided about population, the number of criteria, sub-district data, and village data. The information is presented in the form of a menu where the menu contains a number of data describing the contents of this system, namely information on the socio-economic conditions of each family based on existing criteria. On this home page displays, all information also is presented in a bar graph per year and a pie chart that shows population distribution based on the criteria used in this system.

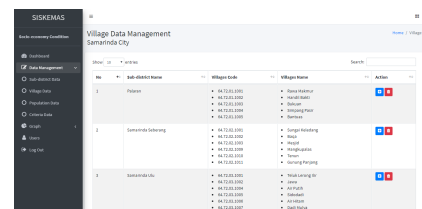

Figure 6: Data on sub-districts and villages

Figure 6 is an interface page which is the contents of the villages menu on the home page. This page presents a list of villages based on sub-districts and also included a unique code for each village in accordance with the standard code of Ministry of Home

Affairs. On this page, the admin manages village data using the action buttons provided.

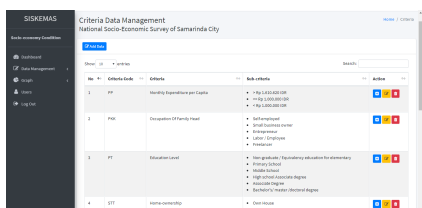

Figure 7: Criteria page interface

The system interface page shown in Figure 7 is the contents of the criteria menu on the main page. This criteria page presents information on socio-economic criteria that describe the condition of people's welfare. Criteria that are managed in this system based on the criteria in table 1. Admin can also manage this page using the action buttons provided.

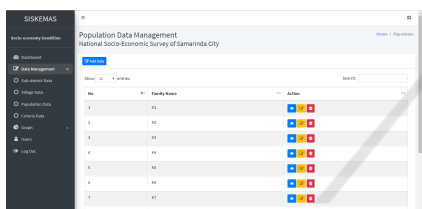

Figure 8: Population data interface

The population page in this system is shown in figure 8 where this page can be accessed through the population menu on the main page. This page provides information on the socio-economic conditions of each family based on the criteria used in this system. To add population data, the admin can click the add button to display the add population data page. There is also an action button for viewing details, changing, and deleting data.

Figure 9 is a pie chart display that displays the distribution of all criteria used in the system, where if one criterion is clicked it will display the distribution of sub-criteria according to the respective criteria.

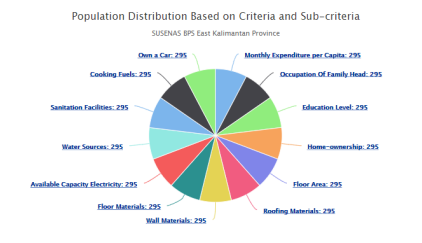

Figure 9: Distribution of criteria

Figure 10 is a pie chart one of the criteria used in the system which is spread into 10 existing sub-districts. Details of criteria distribution can be seen

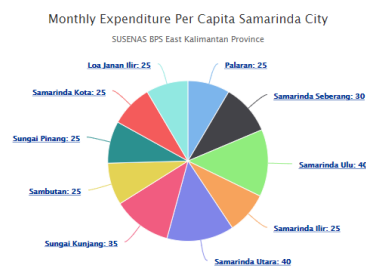

Figure 10: Interface of data of expenditures per capita

by clicking on one of the criteria or names of sub-districts so the distribution of sub-criteria will appear based on the selected criteria.

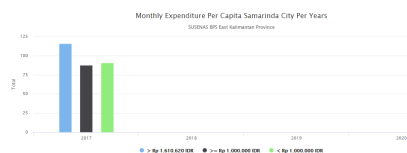

Figure 11: Diagram of data of expenditures per capita

Figure 11 is a bar graph display that presents information on population based on sub-criteria per year. This graph shows a comparison of data on population numbers from year to year from existing sub-criteria.

4 CONCLUSIONS

In this study, information system-based software was built. It is Information System of the socio-economic welfare of society which can display information on the deployment of socio-economic criteria in graphs and circle graphs. This information system can use to facilitate the government or decision makers to get information about the condition of the society as reference material in making the right decisions and policies in poverty alleviation programs and to increase social welfare. Addition of population data to support information can be a concern in future research. The more population data produced the better the information produced. Further development can also add mapping features or geographic information systems to the distribution of community welfare criteria.

REFERENCES

- BPS, B. P. S. (2017). Data tenaga kerja dan angkatan kerja 2017.
- Budiman, E., Dengen, N., Indrawan, W., et al. (2017). Integrated multi criteria decision making for a destitute problem. In *2017 3rd International Conference on Science in Information Technology (ICSITech)*, pages 342–347. IEEE.
- Ependi, U. (2012). Sistem informasi pemetaan data penduduk miskin di kabupaten ogan komering ulu sumatera selatan. In *Digital Information & Systems Conference*, pages 186–190. UK Maranatha.
- Gajewski, T. (2004). *Referenzmodell zur Beschreibung der Geschäftsprozesse von After-Sales-Dienstleistungen unter besonderer Berücksichtigung des Mobile Business*. HNI.
- Kasri, R. A. (2016). Effectiveness of zakah targeting in alleviating poverty in indonesia. *Al-Iqtishad: Jurnal Ilmu Ekonomi Syariah*, 8(2):169–186.
- Maffirotin, S. M., Wati, M., and Setyadi, H. J. (2018). Sistem pendukung keputusan penerima bantuan sosial daerah kutai kartanegara menggunakan metode electre. *Jurnal Rekayasa Teknologi Informasi (JURTI)*, 2(1):9–16.
- Nugroho, A. (2009). *rekayasa perangkat lunak menggunakan UML dan JAVA*. Penerbit Andi.
- Sururi, A. (2017). Pemberdayaan masyarakat melalui program pembangunan infrastruktur perdesaan dalam meningkatkan kesejahteraan masyarakat kecamatan wanasalam kabupaten lebak. *Sawala: Jurnal Administrasi Negara*, 3(2).
- Swastika, D. K. S. and Supriyatna, Y. (2016). The characteristics of poverty and its alleviation in indonesia. In *Forum Penelitian Agro Ekonomi*, volume 26, pages 103–115.
- Thiel, S. et al. (2005). A framework to improve the architecture quality of software-intensive systems.